

Montageanleitung

Assembly instruction

Notice de montage

Montagehandleiding

CT 160

hülsta 



1506775

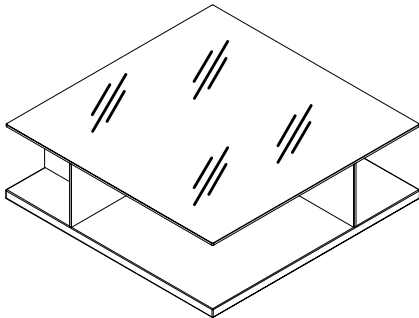
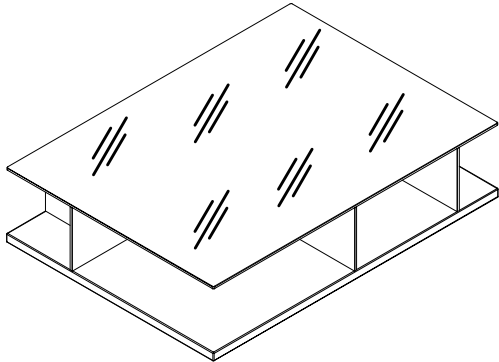

Für die Montage wird benötigt:

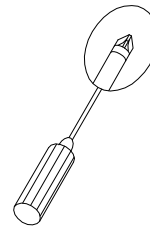
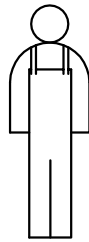

Beschlagbeutel BB 2146

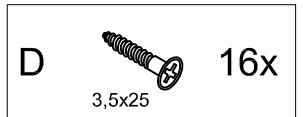

Beschlagbeutel BB 1478

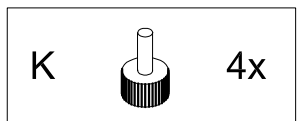

Type **8811, 8812, 8813, 8814**

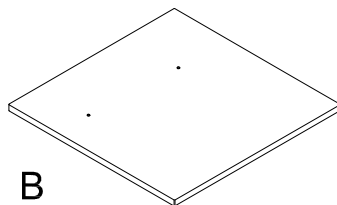
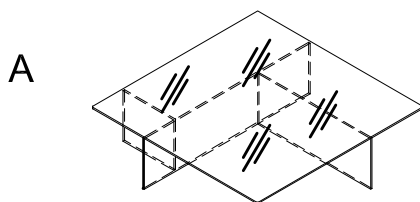

Type **8831, 8832, 8833, 8834**

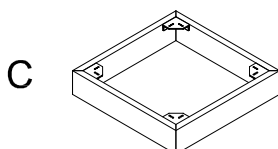

Type **1811, 1812, 1813, 1814**

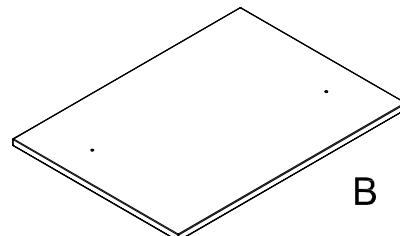
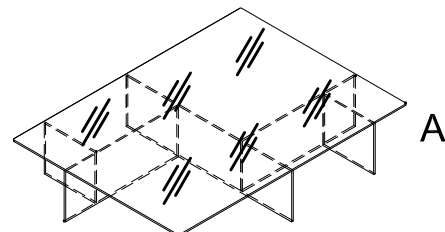

Type **1831, 1832, 1833, 1834**

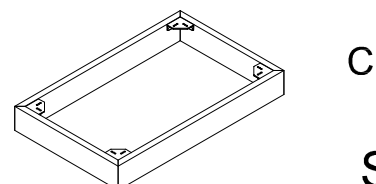

Übersicht Typen rollbar

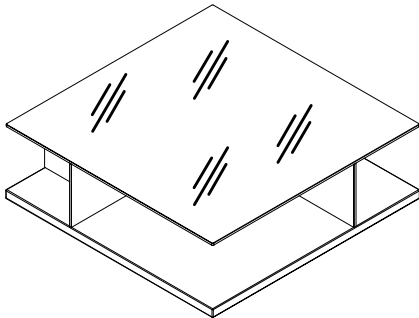
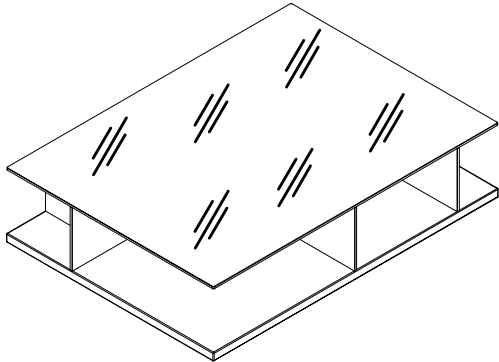

Für die Montage wird benötigt:

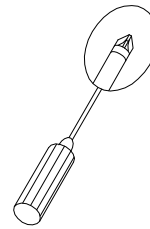
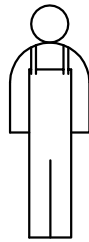

Beschlagbeutel BB 2146



Type 8821, 8822, 8823, 8824

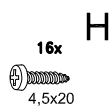
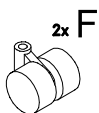
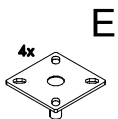
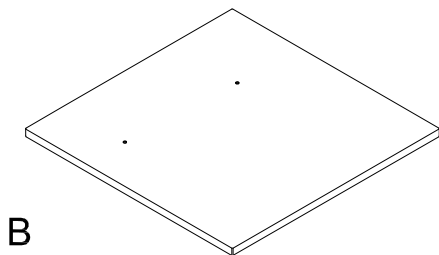
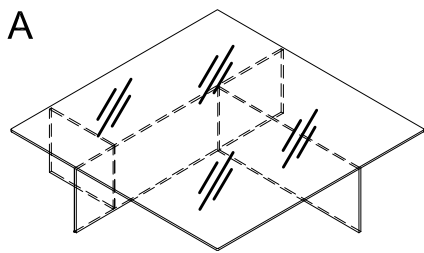

Type 1821, 1822, 1823, 1824

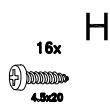
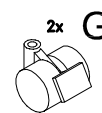
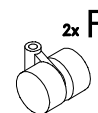
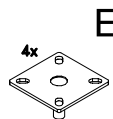
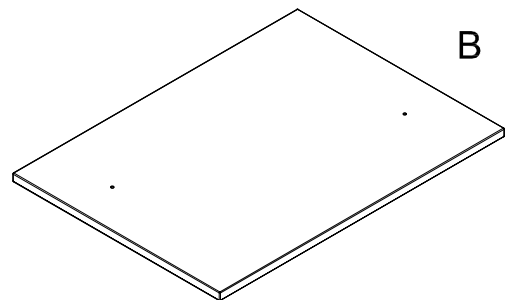
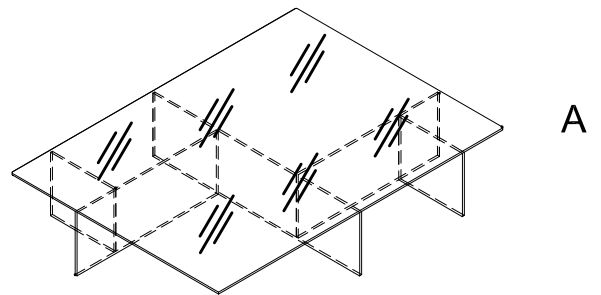

1

Type 8811, 8812, 8813, 8814

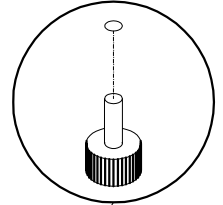
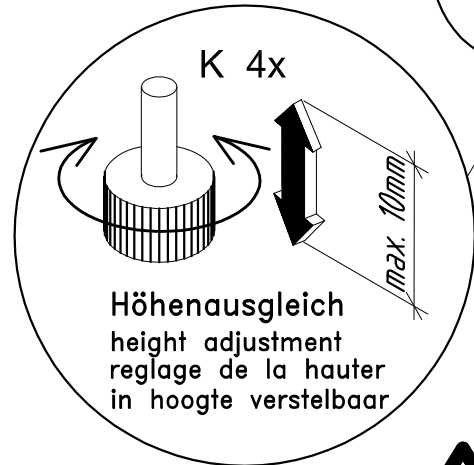
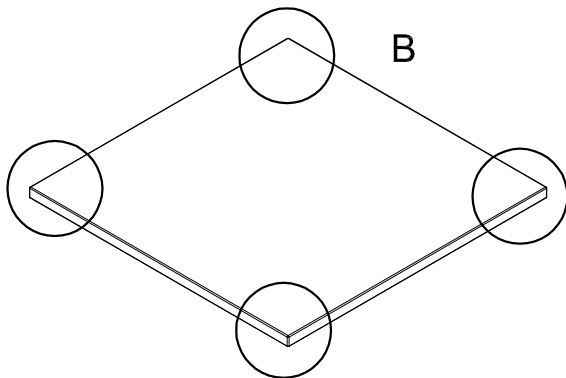

1

Type 1831, 1832, 1833, 1834

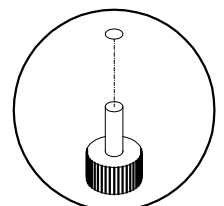
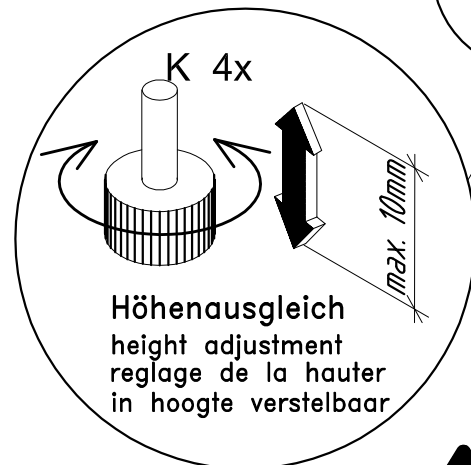
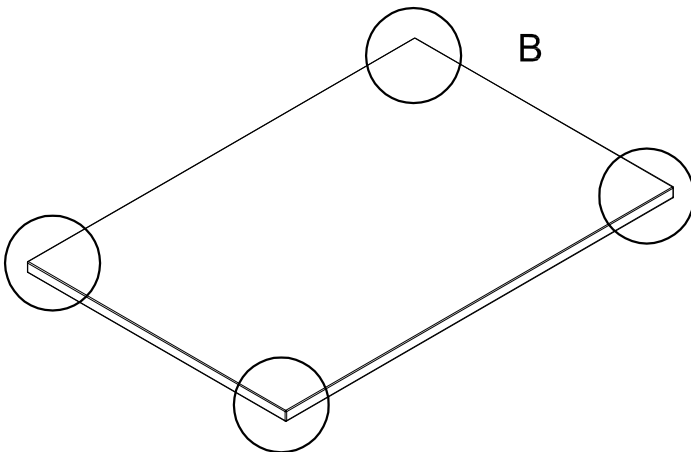

1a Type 8821, 8822, 8823, 8824

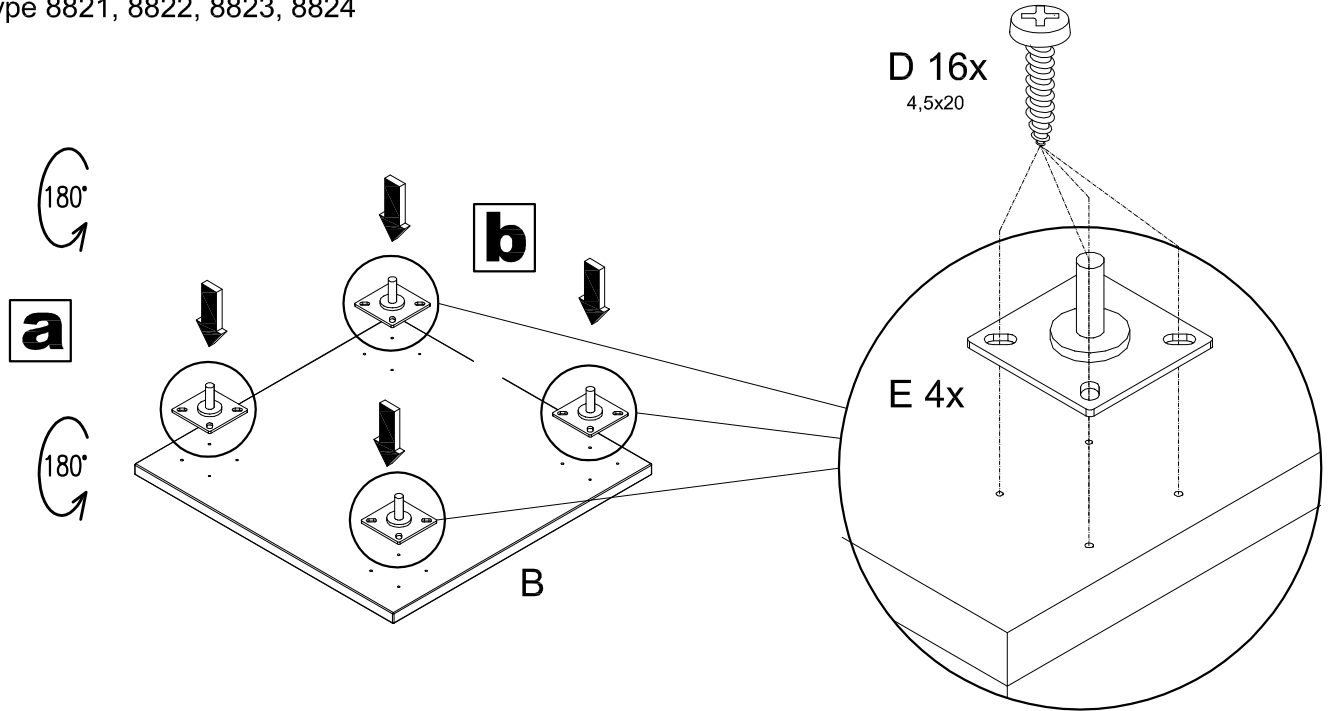

1a Type 1821, 1822, 1823, 1824

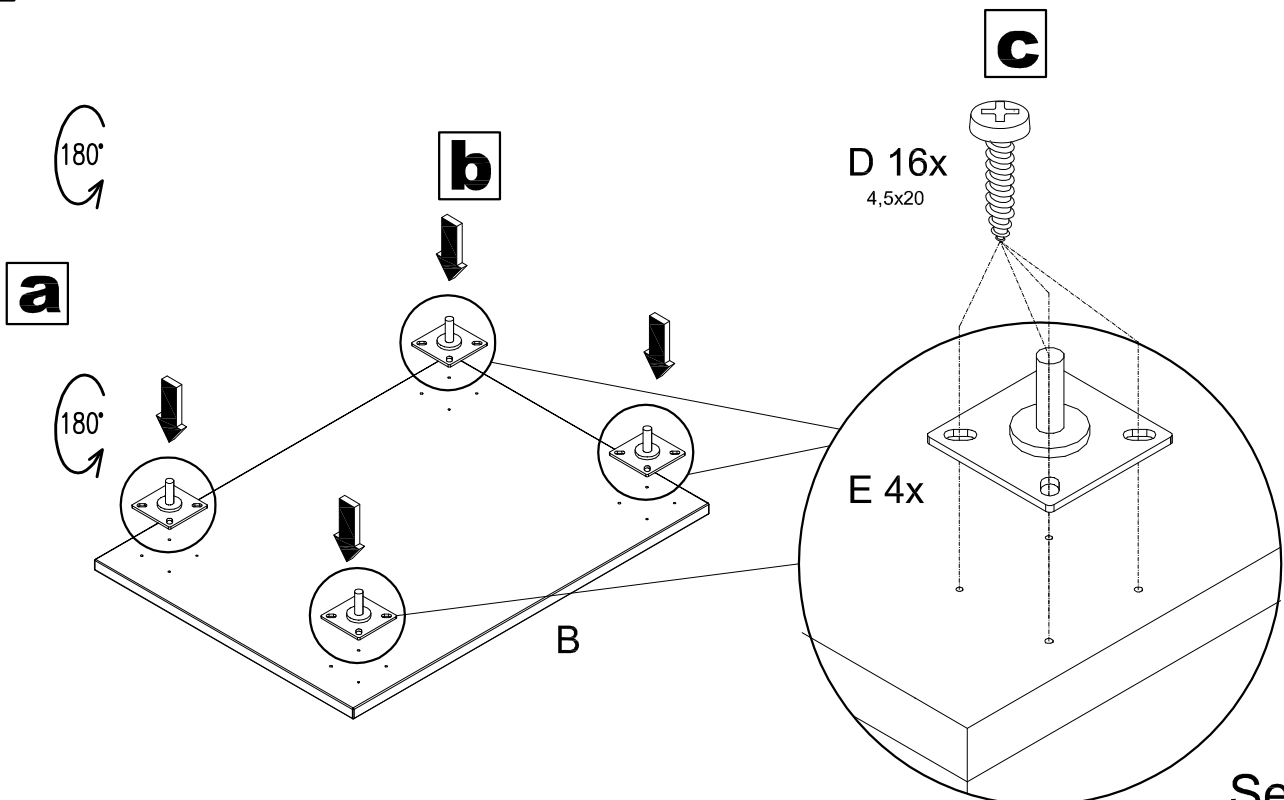

1b

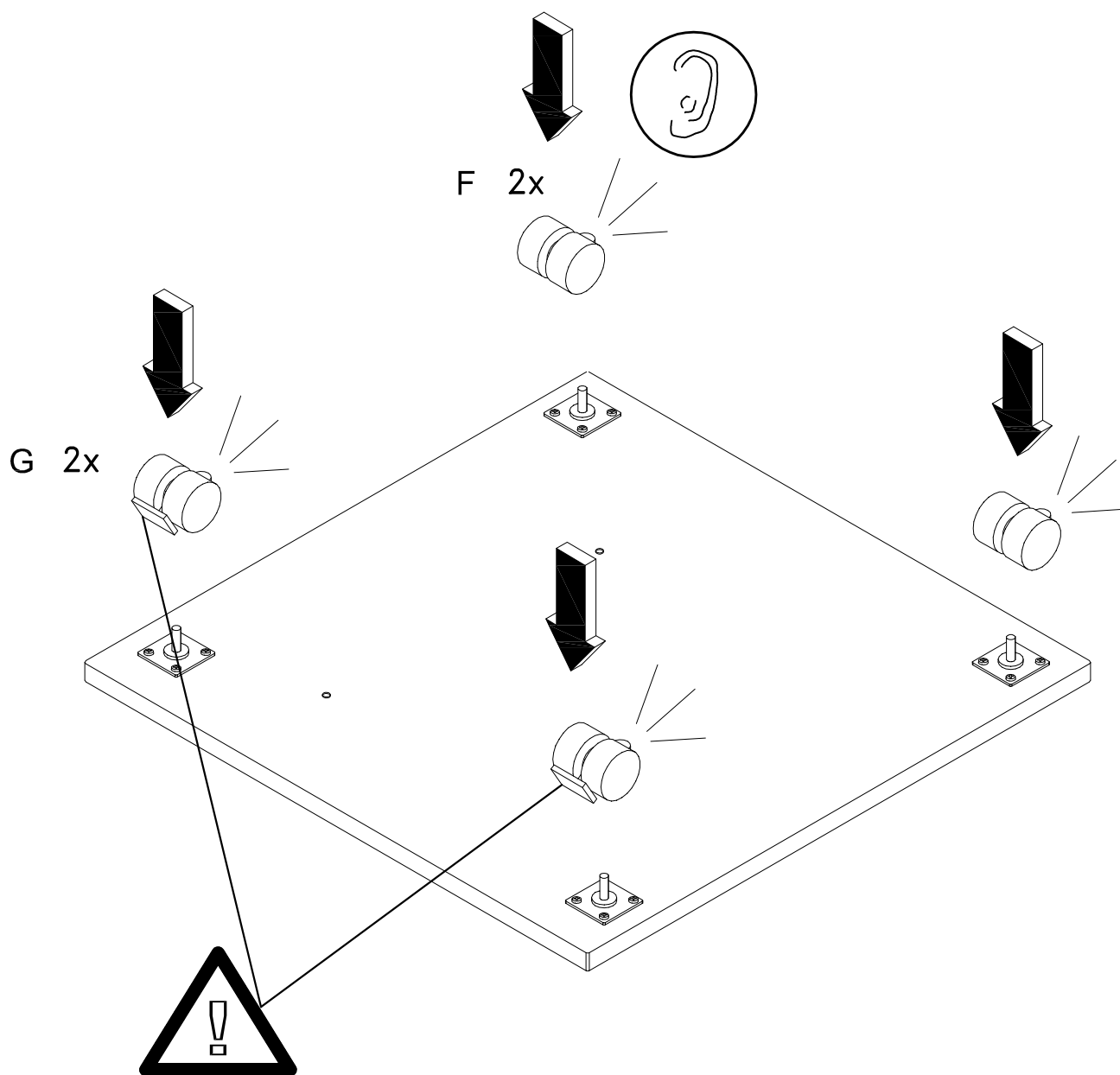

1 Type 8831, 8832, 8833, 8834

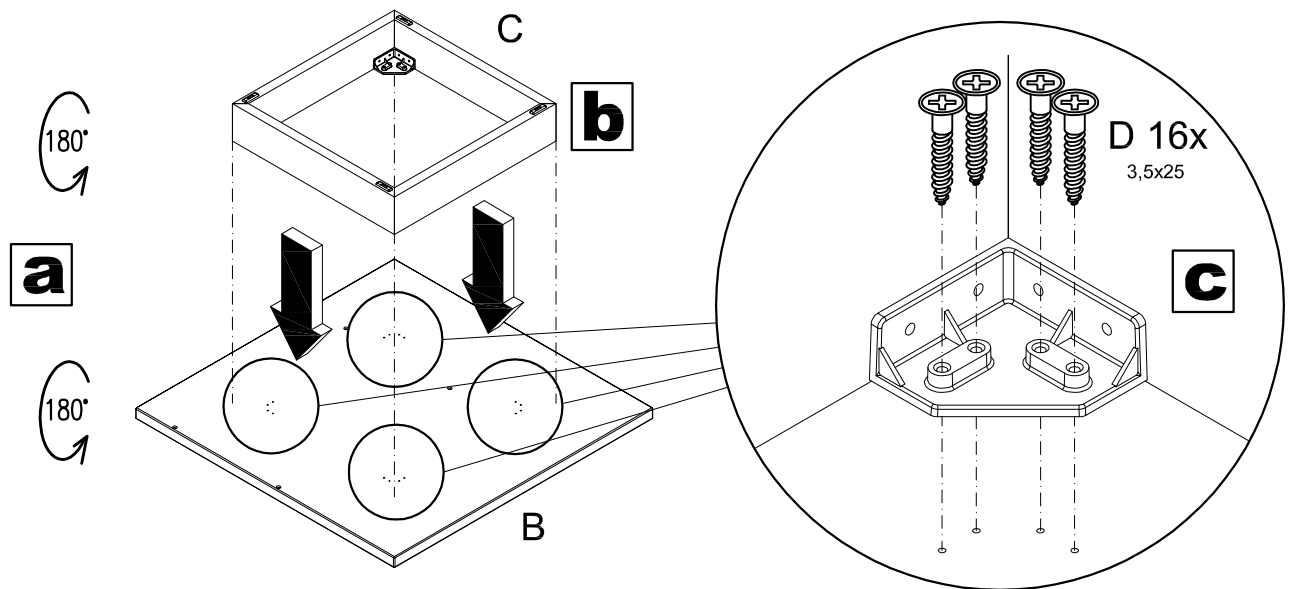

1 Type 1831, 1832, 1833, 1834

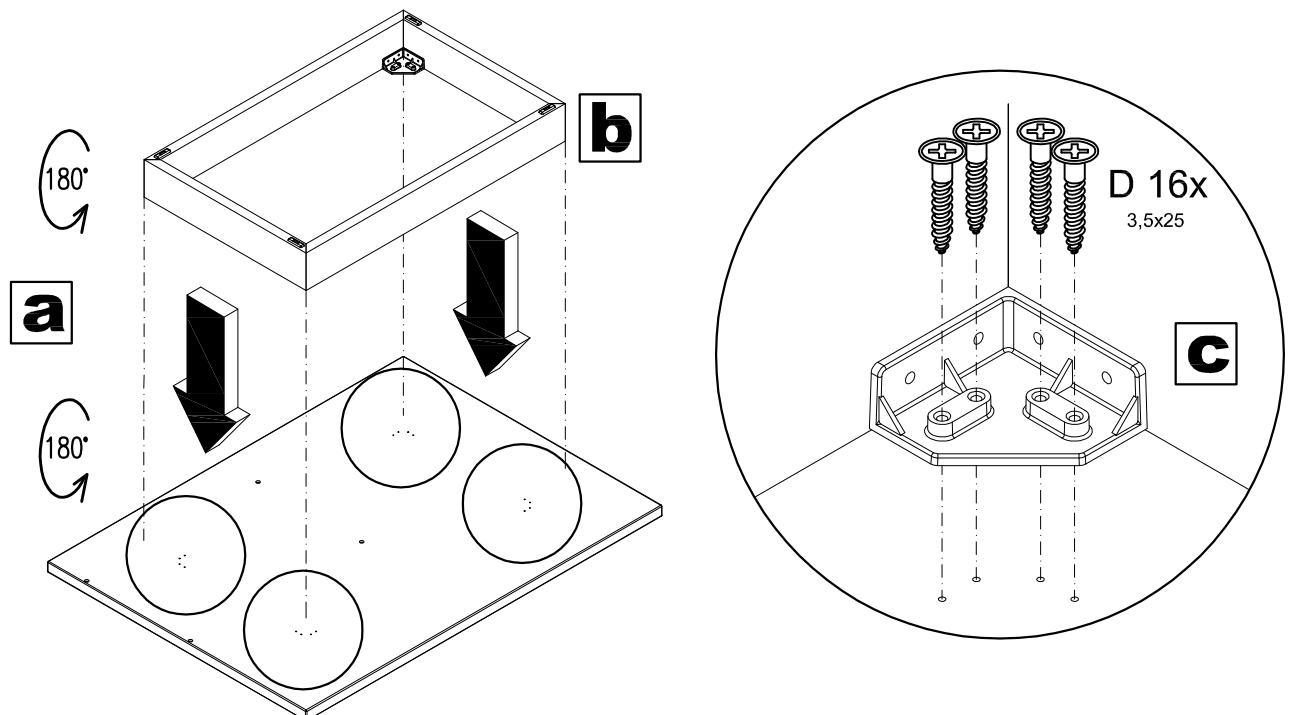

2

Type 80 x 80

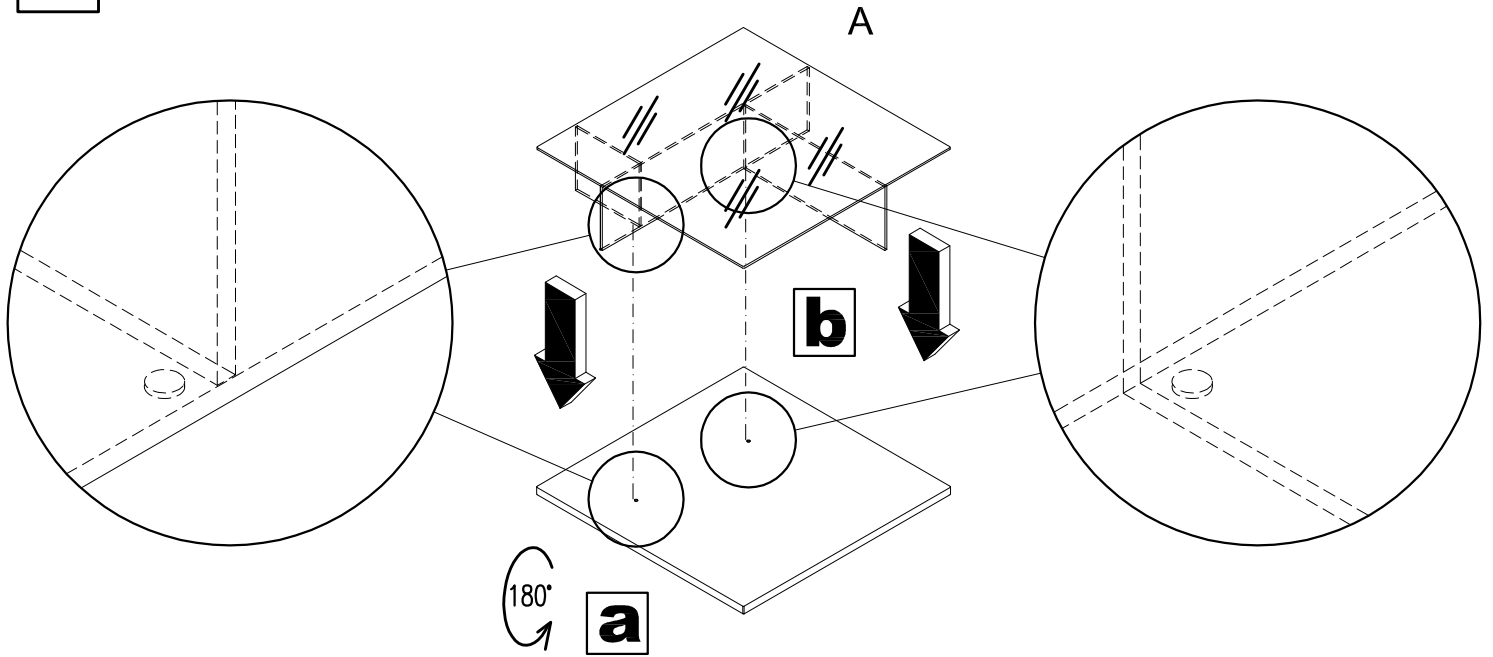

2

Type 110 x 80

