

SPECTRUM

LIVING





SPECTRUM LIVING

Contents

	Page
Range introduction, lists of versions, important notes	2-5
Suggested combinations	6-12
2-3 Raster units / lowboards	13-24
Media accessories for lowboards	25
4-8 Raster units / side- and highboards	26-66
10-12 Raster units / single units	67-77
6-7 Raster wall units	78-80
Fitted shelves, cover panels for corner units, slide-in rear walls, open intermediate units, cover and plinth shelves, legs, wall brackets	81-87
Side-panels, accessories for side-panels	88-91
(TV) wall panels	92-95
Angled shelves, wall shelves, lamps, radio remote control	96-97
Surcharges	98-112
General information:	
Switch options for lamps	114-115
Important notes: quality of walls / assembly instruction	116

Spectrum – Live your style

We bring a new style to life! The new Spectrum range offers trendy colours, hip textures and exclusive materials that turn your creative ideas into reality. Whether a minimalist look or more with bold accents – with Spectrum you can design your rooms according to your own ideas. A hülsta classic with a new charm.

Unlimited versatility, individuality and combinability

Every room is unique and the furniture should reflect this as well. Spectrum can be individually selected according to your needs and room dimensions, creating customised storage solutions that fit perfectly into your life.

Lists of versions

Version no.	Carcase, plinth shelves, side-panel system, carcass of the intermediate units, wall shelves, shelf of the angled shelves	Price group	Version no.	Fronts, cover shelves, rear wall of the intermediate units, (TV) wall panels, niche rear walls, wall panel of the angled shelves	Price group
1058	Pure white lacquer (RAL 9003)	I	1058	Pure white lacquer (RAL 9003)	I
2570	Angora lacquer (RAL 060 8005)	I	2570	Angora lacquer (RAL 060 8005)	I
0664	Anthracite lacquer	I	0664	Anthracite lacquer	I
2589	Come closer lacquer (RAL 050 60 20)	I	2589	Come closer lacquer (RAL 050 60 20)	I
1260	Natural oak	II	1749	Rear-lacquered glass, pure white (RAL 9003)	I
2580	Oak grey	II	2584	Rear-lacquered glass, angora (RAL 060 8005)	I
			2588	Rear-lacquered glass, anthracite	I
			2590	Rear-lacquered glass, come closer (RAL 050 60 20)	I
			1260	Natural oak	II
			2580	Oak grey	II
			2591	Rear-lacquered glass, marble black	II
			2592	Rear-lacquered glass, marble white	II

Front design versions

You can choose between different designs for the fronts and combine them with each other.

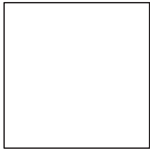
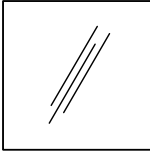
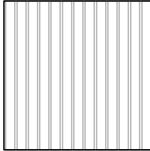
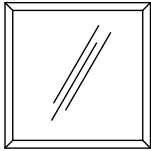
<p>Design Plain (A)</p> 	<p>Design Rear-lacquered glass (B) *</p> 	<p>Design Slat (C) **</p> 	<p>Design Glass (D) ***</p> 
--	---	---	--

* Front for Design B: Rear-lacquered glass on base plate

** Front for Design C: Slat with V-joint

*** Front for Design D: Panel made of clear glass or relief glass in lacquered or veneer-coated aluminium frame

Handles for fronts in Design Plain (A)

All fronts in Design Plain (A) are delivered standard without handles (hülsta-Push-to-open). It is however possible to fit fronts with handles (without surcharge). One handle is fitted on each front. The hülsta-Push-to-open device is not fitted when optional handles are included. If drawers are fitted with handles, these are supplied with hülsta-SoftFlow on hidden roller bearings as fully pullout units, with automatic cushioning device. Handles and hülsta-Push-to-open device cannot be combined within one type.
Please state the type number and the required version clearly in the order!

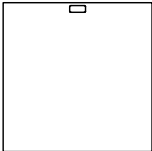
<p>hülsta-Push-to-open Standard</p>  <p>Type GPTO</p>	<p>Handle 057</p>  <p>Pure white lacquer Angora lacquer Anthracite lacquer Come closer lacquer</p> <p>Chrome glossy</p> <p>Type G057 without surcharge</p>
--	---

Fronts in Design Rear-lacquered glass (B), Design Slat (C) and Design Glass (D)

Fronts in Design Rear-lacquered glass (B), Design Slat (C) and Design Glass (D) always with hülsta-Push-to-open device. Handles and hülsta-Push-to-open device cannot be combined within one type.

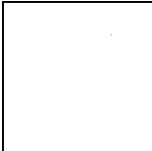
<p>hülsta-Push-to-open Standard for all fronts in Design Rear-lacquered glass (B), Design Slat (C) and Design Glass (D)</p>  <p>Type GPTO</p>
--

Range introduction

Important notes

Changing versions:

Colour combinations within individual units are possible. In this case please state the version number clearly and separately in the order!

Pricing and calculation:

Suggested combinations and units consisting of several individual units are always offered with carcass in price group I and front in price group I in Design Plain (A); exception: units with glass doors in Design Glass (D), see below. If carcass and/or (individual) fronts in versions of price group II and/or fronts in the Design Rear-lacquered glass (B) or Design Slat (C) are required, a surcharge must be taken into account.

Units in Design Glass (D) in a lacquered aluminium frame are always offered with carcass in price group I and front in clear glass – if applicable with further fronts in Design Plain (A) in price group I. If the aluminium frame is desired with a veneer coating and/or the panel is desired in relief glass, a surcharge must be taken into account.

For types that can be planned individually, price group II is also shown.

Drawings in type list – Cover shelves – Note on the furn plan planning programme

All drawings in the type list are shown with 2.8 cm thick cover shelves in wood/lacquer version.

Cover shelves are essential and must be ordered separately (surcharge).

If types are planned in furn plan, a 2.8 cm thick cover shelf is automatically included. These can be exchanged in furn plan for a 1.0 cm thick cover shelf in wood/lacquer version or a 0.8 cm thick cover shelf made of rear-lacquered glass.

Glass fronts Design Glass (D):

Glass doors with a lacquered aluminium frame (standard) or veneer-coated aluminium frame (surcharge), panel of clear glass (standard) or relief glass (surcharge).

Fitted glass shelves:

Glass shelves behind clear glass fronts are made of clear glass.

Glass cover shelves:

Please be sure to state the required version of the rear-lacquered glass cover shelves in the order!

Standard interior fittings:

Wooden shelves are fitted at intervals of 2 rasters behind wooden doors and glass shelves are fitted behind doors with glass fronts in Design Glass (D).

Drawer frames in standard grey

Wall units:

If units are planned as wall units, a wall bracket must be ordered.

Stacked units:

If units are stacked on top of one another, a wall bracket is only to be ordered for the stacked unit(s) if the stacked unit is wider than the floor unit resp. stacked in an off-set position.

Combinations of floor and wall units:

If floor and wall units are combined within an arrangement, there must not be any skirting boards in the room near the floor units, otherwise they must be removed.

Max. load:

Max. load of wooden and glass shelves (up to 70.4 cm width) as well as drawers: 25 kg

Max. load of wooden and glass shelves (between 70.4 and 105.6 cm width): 15 kg

Max. load of wooden and glass shelves (from 105.6 cm width): 10 kg

Max. load of cover shelves: 35 kg per metre length for floor units.

Please also note any existing maximum load information for individual units which may be stated later, the general load information for wall units as well as the important notes on the quality of walls at the end of this type list.

hülsta-Push-to-open/hülsta-SoftFlow:

Doors, drawers and flaps with hülsta Push-to-open. All drawers on hidden bearings as fully pull-out units. If drawers are fitted with handles, these are supplied with hülsta-SoftFlow on hidden roller bearings as fully pull-out units with automatic cushioned closing device.

Wall fitting

Important notes: Generally speaking, you as a dealer/qualified fitter are responsible for the correct wall mounting of the units. That is why wall mounting should only be carried out by properly trained and qualified fitters. hülsta supplies materials for mounting units on walls for nearly all the units and which should be used for safety and for constructional reasons. The assembly materials supplied by hülsta (plugs, screws) are only suitable for fitting components on to concrete in firmness class (C12/15). For other materials (please see separate materials table in the wall composition chapter) we provide you with an assembly mortar set as an extra order. Please note that this assembly mortar set is also only suitable for the materials listed in the materials table. If walls are made up of other materials (e.g. plastered or lighter wall materials), one should use another method of mounting better suited to the load on site. Please note that if the units are not mounted properly on the wall, there is a risk of the units falling down or tipping over – especially when alternative mounting materials acquired on site have been used. For the reasons stated above it is absolutely essential to enquire about the composition of any walls before signing any contracts.

Wall units / stacked units

If the 2 and 3 Raster units as well as lowboards are included as wall units, a maximum load per unit of 15 kg per metre must not be exceeded for reasons of stability! Max. load 15 kg per metre:

35.2 cm width: 5.0 kg	140.8 cm width: 20.0 kg
52.8 cm width: 7.5 kg	158.4 cm width: 20.0 kg
70.4 cm width: 10.0 kg	176.0 cm width: 25.0 kg
88.0 cm width: 12.5 kg	193.6 cm width: 25.0 kg
105.6 cm width: 15.0 kg	211.2 cm width: 30.0 kg
123.2 cm width: 15.0 kg	

If the 4 to 10 Raster units, side- or highboards are included as wall units, a maximum load per unit of 40 kg must not be exceeded for reasons of stability!

The wall units can only be fitted on absolutely solid walls. Light masonry is not suitable for this purpose.

For each project please remember to leave a 2.0 cm gap at the top to be able to mount units.

If units are planned as wall units, a wall bracket must be ordered.

If units are stacked on top of one another, a wall bracket is only to be ordered for the stacked unit(s) if the stacked unit is wider than the floor unit resp. stacked in an off-set position.

Labelling in type list drawings / assembly notes for wall units

Labelling in type list drawings / assembly notes for wall units

The majority of units have two wall mounting points (= number of base plates), if these are to be fitted as wall units. This is not explicitly mentioned in the type list. If a different number of wall mounting points (= base plates) is required, this is marked in the drawings in the type list with numbers in black boxes. Please be sure to note here the information and notes in the "Wall composition" chapter!

3

4

Notes on delivery

Notes on delivery:

Spectrum low-, side- and highboards as well as single units consist of several **component groups** which are **delivered separately** and have to be **assembled on site**. These component groups are the cover shelf and the main carcass resp. the main carcasses.

The fronts of the individual component groups are partially pre-assembled but can be disassembled on site.

Suggested combinations

As an alternative to planning an individual unit from the complete range there is the possibility of choosing from specially suggested combinations. This eases planning. Incorporating accessories can enhance the suggested combinations. These are charged extra.

Surcharges for ...

... carcasses in price group II:
see pages 98-101

... fronts in Design Plain (A)
in price group II:
see pages 102-103

... fronts in Design Rear-
lacquered glass (B)
see page 104

... fronts in Design Slat (C):
see page 105

... fronts in Design Glass (D)
– panel:
see page 106

... fronts in Design Glass (D)
– veneer-covered aluminium
frame:
see page 106

... drawers (instead of flaps):
see page 106

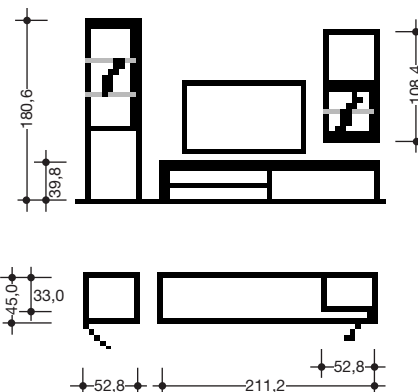
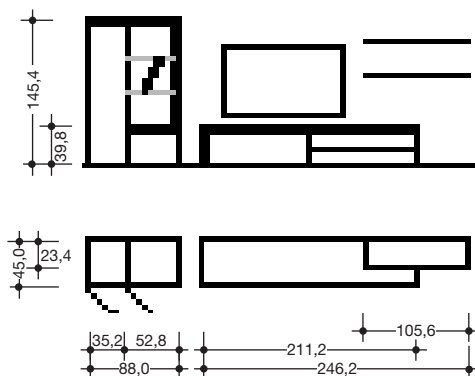

980001

980002

Price gr.
I

-

-

Important note:
Cover shelves are essential
and must be ordered separately
(see pages 84-85)!

**Mirror-image suggested
combinations** are possible.
Please add an „S“ to the type
no. in this case.

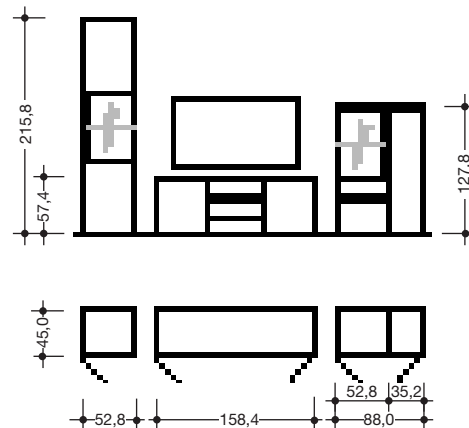
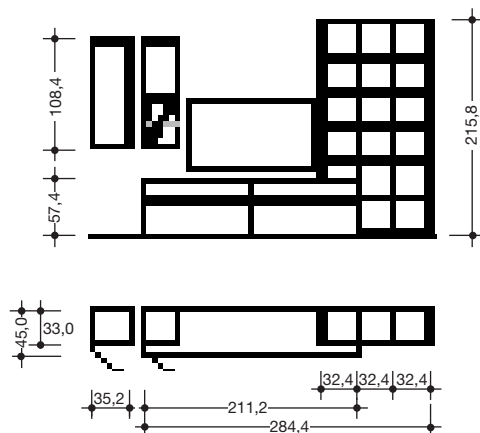

980003

980004

Price gr.
I

-

-

As an alternative to planning an individual unit from the complete range there is the possibility of choosing from specially suggested combinations. This eases planning. Incorporating accessories can enhance the suggested combinations. These are charged extra.

Surcharges for ...

... carcasses in price group II:
see pages 98-101

... fronts in Design Plain (A)
in price group II:
see pages 102-103

... fronts in Design Rear-
lacquered glass (B)
see page 104

... fronts in Design Slat (C):
see page 105

... fronts in Design Glass (D)
– panel:
see page 106

... fronts in Design Glass (D)
– veneer-covered aluminium
frame:
see page 106

... drawers (instead of flaps):
see page 106

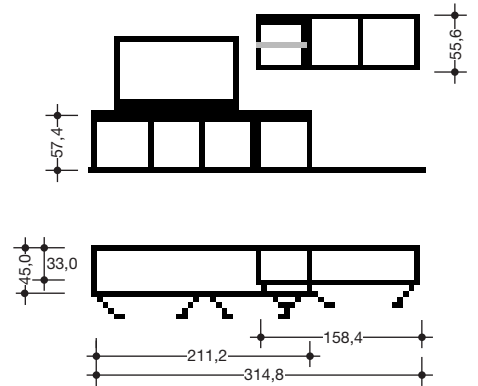
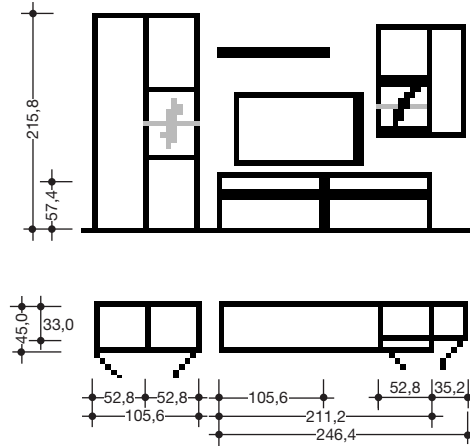

980005

980007

Price gr.
I

Important note:
Cover shelves are essential
and must be ordered separately
(see pages 84-85)!

**Mirror-image suggested
combinations** are possible.
Please add an „S“ to the type
no. in this case.

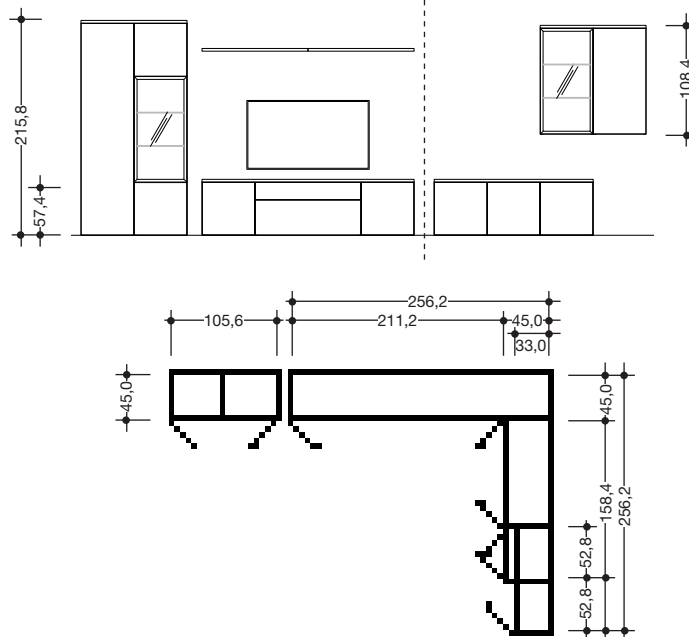

980006

Price gr.
I

Suggested combinations

As an alternative to planning an individual unit from the complete range there is the possibility of choosing from specially suggested combinations. This eases planning. Incorporating accessories can enhance the suggested combinations. These are charged extra.

Surcharges for ...

... carcasses in price group II:
see pages 98-101

... fronts in Design Plain (A)
in price group II:
see pages 102-103

... fronts in Design Rear-
lacquered glass (B)
see page 104

... fronts in Design Slat (C):
see page 105

... fronts in Design Glass (D)
- panel:
see page 106

... fronts in Design Glass (D)
- veneer-covered aluminium
frame:
see page 106

... drawers (instead of flaps):
see page 106

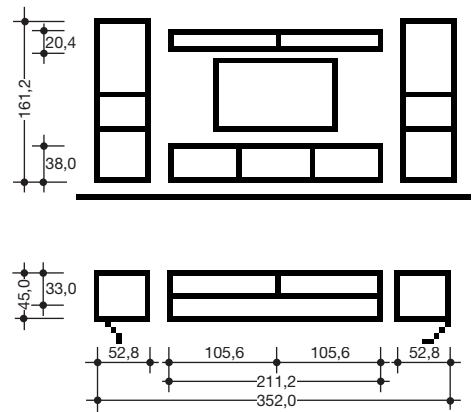
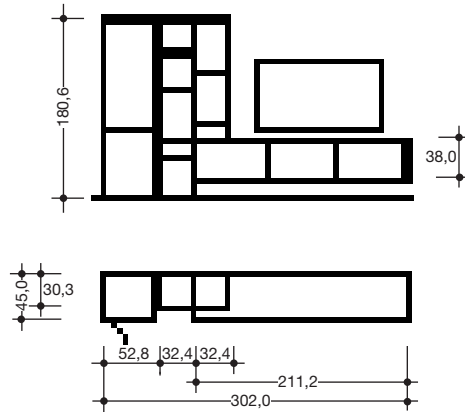

980008

980009

Price gr.
I

-

-

Important note:
Cover shelves are essential
and must be ordered separately
(see pages 84-85)!

**Mirror-image suggested
combinations** are possible.
Please add an „S“ to the type
no. in this case.

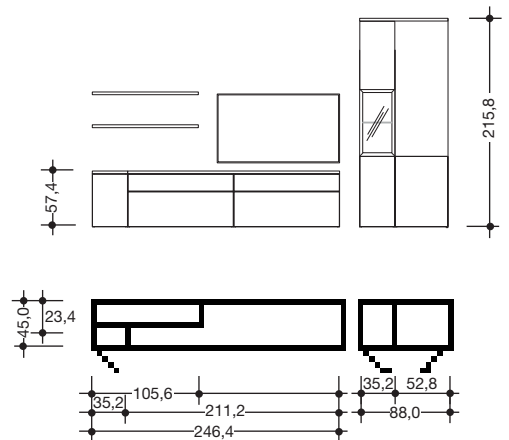
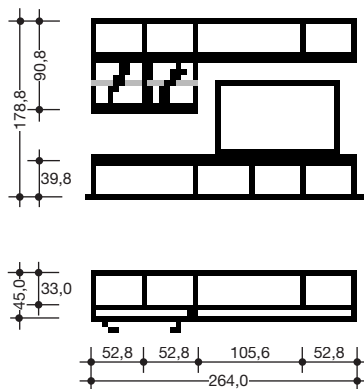

980010

980011

Price gr.
I

-

-

As an alternative to planning an individual unit from the complete range there is the possibility of choosing from specially suggested combinations. This eases planning. Incorporating accessories can enhance the suggested combinations. These are charged extra.

Surcharges for ...

... carcasses in price group II:
see pages 98-101

... fronts in Design Plain (A)
in price group II:
see pages 102-103

... fronts in Design Rear-
lacquered glass (B)
see page 104

... fronts in Design Slat (C):
see page 105

... fronts in Design Glass (D)
– panel:
see page 106

... fronts in Design Glass (D)
– veneer-covered aluminium
frame:
see page 106

... drawers (instead of flaps):
see page 106

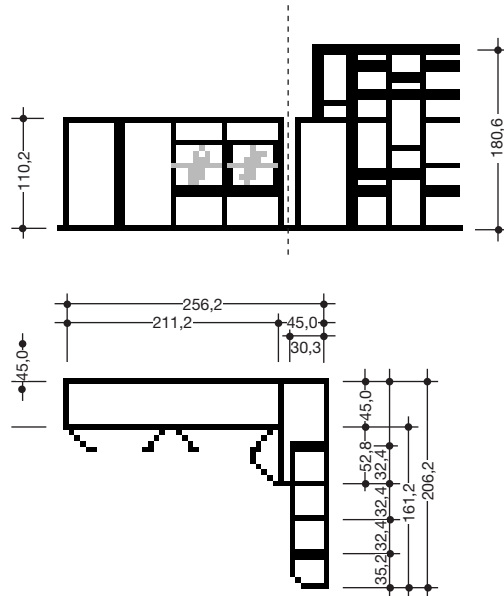

980012

Price gr.
I

Important note:
Cover shelves are essential
and must be ordered separately
(see pages 84-85)!

**Mirror-image suggested
combinations** are possible.
Please add an „S“ to the type
no. in this case.

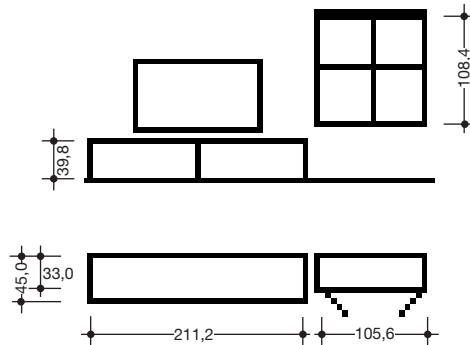

980013

Price gr.
I

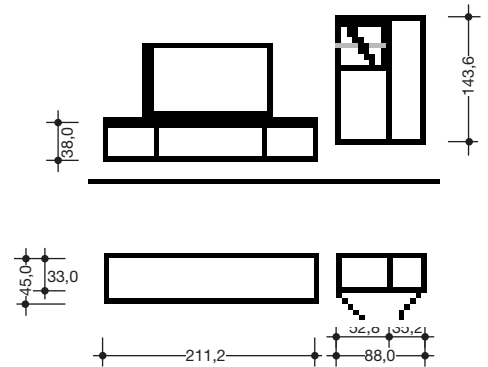

980014

Suggested combinations

As an alternative to planning an individual unit from the complete range there is the possibility of choosing from specially suggested combinations. This eases planning. Incorporating accessories can enhance the suggested combinations. These are charged extra.

Surcharges for ...

... carcasses in price group II:
see pages 98-101

... fronts in Design Plain (A)
in price group II:
see pages 102-103

... fronts in Design Rear-
lacquered glass (B)
see page 104

... fronts in Design Slat (C):
see page 105

... fronts in Design Glass (D)
- panel:
see page 106

... fronts in Design Glass (D)
- veneer-covered aluminium
frame:
see page 106

... drawers (instead of flaps):
see page 106

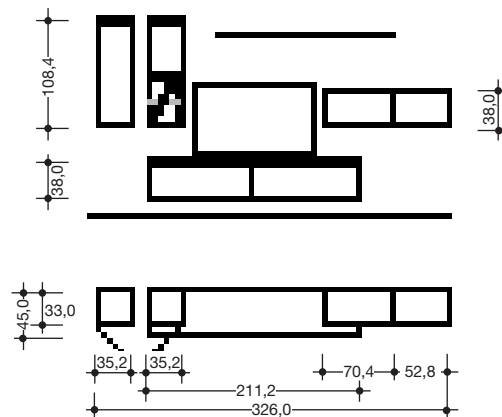
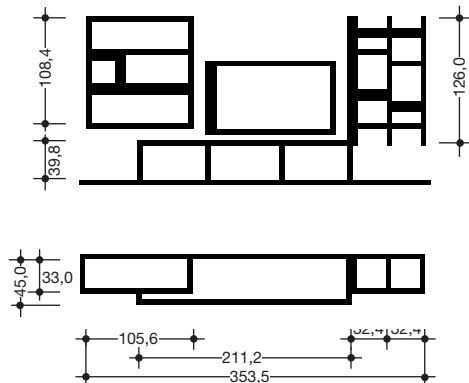

980015

980016

Price gr.
I

-

-

Important note:
Cover shelves are essential
and must be ordered separately
(see pages 84-85)!

**Mirror-image suggested
combinations** are possible.
Please add an „S“ to the type
no. in this case.

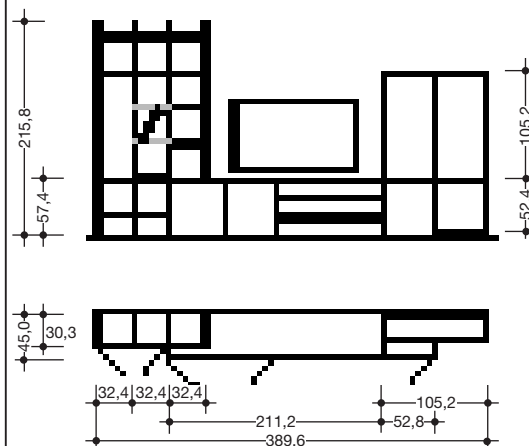
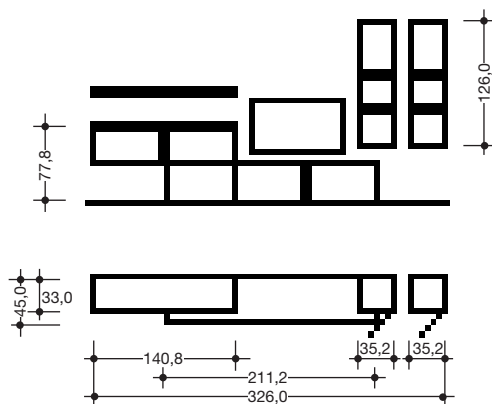

980017

980018

Price gr.
I

-

-

As an alternative to planning an individual unit from the complete range there is the possibility of choosing from specially suggested combinations. This eases planning. Incorporating accessories can enhance the suggested combinations. These are charged extra.

Surcharges for ...

... carcasses in price group II:
see pages 98-101

... fronts in Design Plain (A)
in price group II:
see pages 102-103

... fronts in Design Rear-
lacquered glass (B)
see page 104

... fronts in Design Slat (C):
see page 105

... fronts in Design Glass (D)
– panel:
see page 106

... fronts in Design Glass (D)
– veneer-covered aluminium
frame:
see page 106

... drawers (instead of flaps):
see page 106

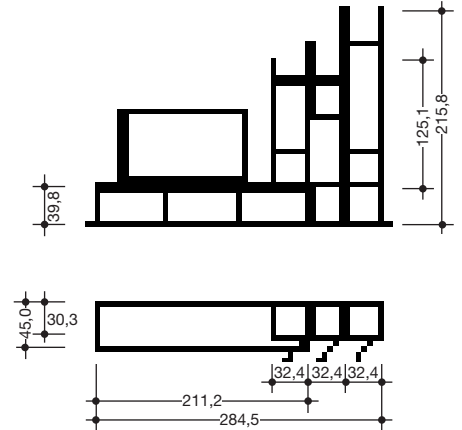
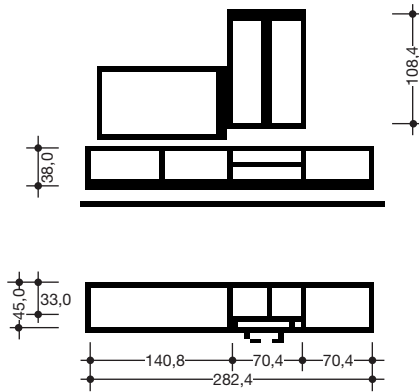

Price gr.
I

980019

980020

Important note:
Cover shelves are essential
and must be ordered separately
(see pages 84-85)!

**Mirror-image suggested
combinations** are possible.
Please add an „S“ to the type
no. in this case.

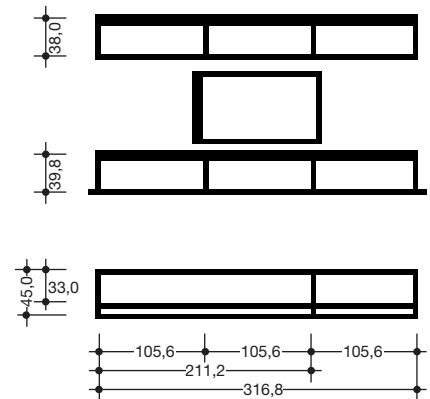
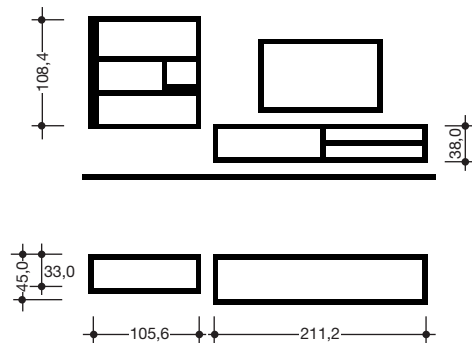

Price gr.
I

980021

980022

Suggested combinations

As an alternative to planning an individual unit from the complete range there is the possibility of choosing from specially suggested combinations. This eases planning. Incorporating accessories can enhance the suggested combinations. These are charged extra.

Surcharges for ...

... carcasses in price group II:
see pages 98-101

... fronts in Design Plain (A)
in price group II:
see pages 102-103

... fronts in Design Rear-
lacquered glass (B)
see page 104

... fronts in Design Slat (C):
see page 105

... fronts in Design Glass (D)
- panel:
see page 106

... fronts in Design Glass (D)
- veneer-covered aluminium
frame:
see page 106

... drawers (instead of flaps):
see page 106

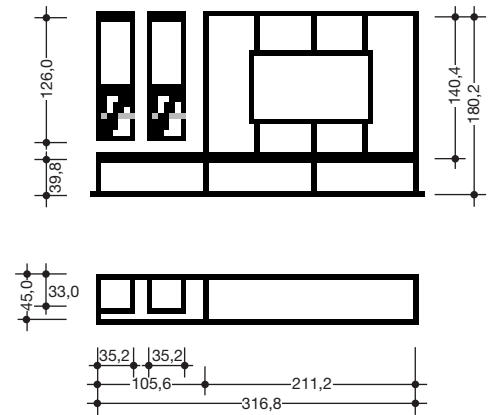
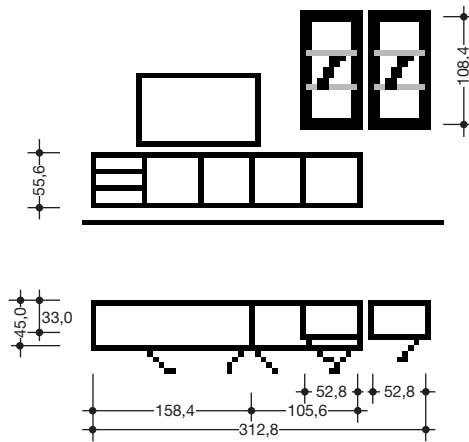

980023

980024

Price gr.
I

-

-

Important note:
Cover shelves are essential
and must be ordered separately
(see pages 84-85)!

**Mirror-image suggested
combinations** are possible.
Please add an „S“ to the type
no. in this case.

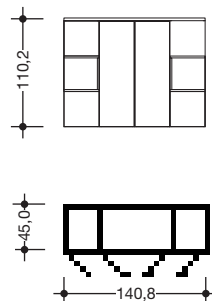

980025

Price gr.
I



-

Notes on delivery:
Please see here the information on range introduction pages.

Assembly notes for wall units:
Please be sure to note here the information and notes in the "Wall composition" chapter!

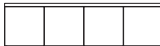

2 Raster units / lowboards

SPECTRUM

<p>2 Raster units / lowboards 35.2 cm high (37.0 cm high incl. 1.8 cm high plinth adjusters), 33.0 or 45.0 cm deep</p> <p>Surcharges for ...</p> <p>... carcasses in price group II: see pages 98-101</p> <p>... fronts in Design Plain (A) in price group II: see pages 102-103</p> <p>... fronts in Design Rear-lacquered glass (B) see page 104</p> <p>... fronts in Design Slat (C): see page 105</p> <p>... fronts in Design Glass (D) – panel: see page 106</p> <p>... fronts in Design Glass (D) – veneer-covered aluminium frame: see page 106</p> <p>... drawers (instead of flaps): see page 106</p> <p>Important note: Cover shelves are essential and must be ordered separately (see pages 84-85)!</p> <p>When used as wall units or stacked units: Max. load 15 kg per metre: 35.2 cm width: 5.0 kg 52.8 cm width: 7.5 kg 70.4 cm width: 10.0 kg 105.6 cm width: 15.0 kg 123.2 cm width: 15.0 kg 140.8 cm width: 20.0 kg 158.4 cm width: 20.0 kg 176.0 cm width: 25.0 kg 193.6 cm width: 25.0 kg 211.2 cm width: 30.0 kg</p>	1 door in Design Plain (A)				
					
	Width		Type no.		Price group I
			Door hinge left	Door hinge right	
	33.0 cm deep	35,2 cm – as illustrated	5202101	5202102	-
		70,4 cm – 2 doors	5204101		-
	45.0 cm deep	35,2 cm – as illustrated	5202201	5202202	-
		70,4 cm – 2 doors	5204201		-
	4 doors in Design Plain (A)				
					
Width (individual unit widths)		Type no.		Price group I	
33.0 cm deep	140,8 cm (70,4 + 70,4 cm) – as illustrated	5208101		-	
45.0 cm deep	140,8 cm (70,4 + 70,4 cm) – as illustrated	5208201		-	
6 doors in Design Plain (A)					
					
Width (individual unit widths)		Type no.		Price group I	
33.0 cm deep	211,2 cm (70,4 + 70,4 + 70,4 cm) – as illustrated	5212101		-	
45.0 cm deep	211,2 cm (70,4 + 70,4 + 70,4 cm) – as illustrated	5212201		-	

2 Raster units / lowboards

Accessories and lamps:
see pages 25 and 97

<p>2 Raster units / lowboards 35.2 cm high (37.0 cm high incl. 1.8 cm high plinth adjusters), 33.0 or 45.0 cm deep</p> <p>Surcharges for ...</p> <p>... carcasses in price group II: see pages 98-101</p> <p>... fronts in Design Plain (A) in price group II: see pages 102-103</p> <p>... fronts in Design Rear-lacquered glass (B) see page 104</p> <p>... fronts in Design Slat (C): see page 105</p> <p>... fronts in Design Glass (D) – panel: see page 106</p> <p>... fronts in Design Glass (D) – veneer-covered aluminium frame: see page 106</p> <p>... drawers (instead of flaps): see page 106</p>	1 flap in Design Plain (A)			
				
		Width	Type no.	Price group I
	33.0 cm deep	35,2 cm	5202103	-
		52,8 cm – as illustrated	5203103	-
		70,4 cm	5204103	-
		105,6 cm	5206103	-
	45.0 cm deep	35,2 cm	5202203	-
		52,8 cm – as illustrated	5203203	-
		70,4 cm	5204203	-
105,6 cm		5206203	-	
2 flaps in Design Plain (A)				
				
	Width (individual unit widths)	Type no.	Price group I	
33.0 cm deep	140,8 cm (70,4 + 70,4 cm) – as illustrated	5208102	-	
	211,2 cm (105,6 + 105,6 cm)	5212102	-	
45.0 cm deep	140,8 cm (70,4 + 70,4 cm) – as illustrated	5208202	-	
	211,2 cm (105,6 + 105,6 cm)	5212202	-	
3 flaps in Design Plain (A)				
				
	Width (individual unit widths)	Type no.	Price group I	
33.0 cm deep	158,4 cm (52,8 + 52,8 + 52,8 cm) – as illustrated	3 5209103	-	
	176,0 cm (52,8 + 70,4 + 52,8 cm)	4 5210103	-	
	193,6 cm (70,4 + 52,8 + 70,4 cm)	4 5211103	-	
	211,2 cm (70,4 + 70,4 + 70,4 cm)	4 5212103	-	
	211,2 cm (52,8 + 105,6 + 52,8 cm)	4 5212109	-	
45.0 cm deep	158,4 cm (52,8 + 52,8 + 52,8 cm) – as illustrated	3 5209203	-	
	176,0 cm (52,8 + 70,4 + 52,8 cm)	4 5210203	-	
	193,6 cm (70,4 + 52,8 + 70,4 cm)	4 5211203	-	
	211,2 cm (70,4 + 70,4 + 70,4 cm)	4 5212203	-	
	211,2 cm (52,8 + 105,6 + 52,8 cm)	4 5212209	-	
<p>Important note: Cover shelves are essential and must be ordered separately (see pages 84-85)!</p> <p>Please state for 2 Raster flaps the flap hinge (top or bottom) clearly in the order!</p>				
<p>When used as wall units or stacked units: Max. load 15 kg per metre: 35.2 cm width: 5.0 kg 52.8 cm width: 7.5 kg 70.4 cm width: 10.0 kg 105.6 cm width: 15.0 kg 123.2 cm width: 15.0 kg 140.8 cm width: 20.0 kg 158.4 cm width: 20.0 kg 176.0 cm width: 25.0 kg 193.6 cm width: 25.0 kg 211.2 cm width: 30.0 kg</p>				

Notes on delivery:
Please see here the information on range introduction pages.

Assembly notes for wall units:
Please be sure to note here the information and notes in the "Wall composition" chapter!

2 Raster units / lowboards

SPECTRUM

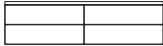
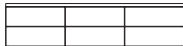
2 Raster units / lowboards 35.2 cm high (37.0 cm high incl. 1.8 cm high plinth adjusters), 33.0 or 45.0 cm deep		2 drawers in Design Plain (A)		
Surcharges for carcasses in price group II: see pages 98-101 ... fronts in Design Plain (A) in price group II: see pages 102-103 ... fronts in Design Rear-lacquered glass (B) see page 104 ... fronts in Design Slat (C): see page 105 ... fronts in Design Glass (D) – panel: see page 106 ... fronts in Design Glass (D) – veneer-covered aluminium frame: see page 106 ... drawers (instead of flaps): see page 106				
		Width	Type no.	Price group I
33.0 cm deep	35,2 cm	5202104	-	
	52,8 cm – as illustrated	5203104	-	
	70,4 cm	5204104	-	
	105,6 cm	5206104	-	
45.0 cm deep	35,2 cm	5202204	-	
	52,8 cm – as illustrated	5203204	-	
	70,4 cm	5204204	-	
	105,6 cm	5206204	-	
Important note: Cover shelves are essential and must be ordered separately (see pages 84-85)!		4 drawers in Design Plain (A) 		
		Width (individual unit widths)	Type no.	Price group I
33.0 cm deep	140,8 cm (70,4 + 70,4 cm) – as illustrated	5208106	-	
	211,2 cm (105,6 + 105,6 cm)	5212106	-	
45.0 cm deep	140,8 cm (70,4 + 70,4 cm) – as illustrated	5208206	-	
	211,2 cm (105,6 + 105,6 cm)	5212206	-	
Important note: Cover shelves are essential and must be ordered separately (see pages 84-85)!		6 drawers in Design Plain (A) 		
		Width (individual unit widths)	Type no.	Price group I
33.0 cm deep	123,2 cm (35,2 + 52,8 + 35,2 cm)	3 5207107	-	
	140,8 cm (35,2 + 70,4 + 35,2 cm)	3 5208107	-	
	158,4 cm (52,8 + 52,8 + 52,8 cm) – as illustrated	3 5209107	-	
	176,0 cm (52,8 + 70,4 + 52,8 cm)	4 5210107	-	
	193,6 cm (70,4 + 52,8 + 70,4 cm)	4 5211107	-	
	211,2 cm (70,4 + 70,4 + 70,4 cm)	4 5212107	-	
	211,2 cm (52,8 + 105,6 + 52,8 cm)	4 5212108	-	
45.0 cm deep	123,2 cm (35,2 + 52,8 + 35,2 cm)	3 5207207	-	
	140,8 cm (35,2 + 70,4 + 35,2 cm)	3 5208207	-	
	158,4 cm (52,8 + 52,8 + 52,8 cm) – as illustrated	3 5209207	-	
	176,0 cm (52,8 + 70,4 + 52,8 cm)	4 5210207	-	
	193,6 cm (70,4 + 52,8 + 70,4 cm)	4 5211207	-	
	211,2 cm (70,4 + 70,4 + 70,4 cm)	4 5212207	-	
	211,2 cm (52,8 + 105,6 + 52,8 cm)	4 5212208	-	
When used as wall units or stacked units: Max. load 15 kg per metre: 35.2 cm width: 5.0 kg 52.8 cm width: 7.5 kg 70.4 cm width: 10.0 kg 105.6 cm width: 15.0 kg 123.2 cm width: 15.0 kg 140.8 cm width: 20.0 kg 158.4 cm width: 20.0 kg 176.0 cm width: 25.0 kg 193.6 cm width: 25.0 kg 211.2 cm width: 30.0 kg				

2 Raster units / lowboards

Accessories and lamps:
see pages 25 and 97

1 flap and 2 drawers in Design Plain (A)



2 Raster units / lowboards
35.2 cm high
(37.0 cm high incl. 1.8 cm high plinth adjusters),
33.0 or 45.0 cm deep

Surcharges for ...

... carcasses in price group II:
see pages 98-101

... fronts in Design Plain (A)
in price group II:
see pages 102-103

... fronts in Design Rear-lacquered glass (B)
see page 104

... fronts in Design Slat (C):
see page 105

... fronts in Design Glass (D)
– panel:
see page 106

... fronts in Design Glass (D)
– veneer-covered aluminium frame:
see page 106

... drawers (instead of flaps):
see page 106

	Width (individual unit widths)	Type no.	Price group I
33,0 cm deep	140,8 cm (70,4 + 70,4 cm) – as illustrated	5208104	-
	211,2 cm (105,6 + 105,6 cm)	5212104	-
45,0 cm deep	140,8 cm (70,4 + 70,4 cm) – as illustrated	5208204	-
	211,2 cm (105,6 + 105,6 cm)	5212204	-

Important note:
Cover shelves are essential and must be ordered separately (see pages 84-85)!

Mirror-image types are possible. Please add an „S“ to the type no. in this case.

Please state for 2 Raster flaps the **flap hinge** (top or bottom) clearly in the order!

When used as wall units or stacked units:
Max. load 15 kg per metre:
35.2 cm width: 5.0 kg
52.8 cm width: 7.5 kg
70.4 cm width: 10.0 kg
105.6 cm width: 15.0 kg
123.2 cm width: 15.0 kg
140.8 cm width: 20.0 kg
158.4 cm width: 20.0 kg
176.0 cm width: 25.0 kg
193.6 cm width: 25.0 kg
211.2 cm width: 30.0 kg

Notes on delivery:
Please see here the information on range introduction pages.

Assembly notes for wall units:
Please be sure to note here the information and notes in the "Wall composition" chapter!

2 Raster units / lowboards

SPECTRUM

<p>2 Raster units / lowboards 35.2 cm high (37.0 cm high incl. 1.8 cm high plinth adjusters), 33.0 or 45.0 cm deep</p> <p>Surcharges for ...</p> <p>... carcasses in price group II: see pages 98-101</p> <p>... fronts in Design Plain (A) in price group II: see pages 102-103</p> <p>... fronts in Design Rear-lacquered glass (B) see page 104</p> <p>... fronts in Design Slat (C): see page 105</p> <p>... fronts in Design Glass (D) – panel: see page 106</p> <p>... fronts in Design Glass (D) – veneer-covered aluminium frame: see page 106</p> <p>... drawers (instead of flaps): see page 106</p> <p>Important note: Cover shelves are essential and must be ordered separately (see pages 84-85)!</p> <p>Mirror-image types are possible. Please add an „S“ to the type no. in this case.</p> <p>Please state for 2 Raster flaps the flap hinge (top or bottom) clearly in the order!</p> <p>When used as wall units or stacked units: Max. load 15 kg per metre: 35.2 cm width: 5.0 kg 52.8 cm width: 7.5 kg 70.4 cm width: 10.0 kg 105.6 cm width: 15.0 kg 123.2 cm width: 15.0 kg 140.8 cm width: 20.0 kg 158.4 cm width: 20.0 kg 176.0 cm width: 25.0 kg 193.6 cm width: 25.0 kg 211.2 cm width: 30.0 kg</p>	2 flaps and 2 drawers in Design Plain (A)			
		Width (individual unit widths)	Type no.	Price group I
	33.0 cm deep	158,4 cm (52,8 + 52,8 + 52,8 cm) – as illustrated	3 5209105	-
		176,0 cm (52,8 + 70,4 + 52,8 cm)	4 5210105	-
		193,6 cm (70,4 + 52,8 + 70,4 cm)	4 5211105	-
		211,2 cm (52,8 + 105,6 + 52,8 cm)	4 5212105	-
	45.0 cm deep	158,4 cm (52,8 + 52,8 + 52,8 cm) – as illustrated	3 5209205	-
		176,0 cm (52,8 + 70,4 + 52,8 cm)	4 5210205	-
		193,6 cm (70,4 + 52,8 + 70,4 cm)	4 5211205	-
211,2 cm (52,8 + 105,6 + 52,8 cm)		4 5212205	-	
2 doors and 2 drawers in Design Plain (A)				
	Width (individual unit widths)	Type no.	Price group I	
33.0 cm deep	123,2 cm (35,2 + 52,8 + 35,2 cm)	5207109	-	
	140,8 cm (35,2 + 70,4 + 35,2 cm) – as illustrated	5208109	-	
45.0 cm deep	123,2 cm (35,2 + 52,8 + 35,2 cm)	5207209	-	
	140,8 cm (35,2 + 70,4 + 35,2 cm) – as illustrated	5208209	-	
3 doors and 2 drawers in Design Plain (A)				
	Width (individual unit widths)	Type no.	Price group I	
33.0 cm deep	140,8 cm (70,4 + 35,2 + 35,2 cm) – as illustrated	5208108	-	
	176,0 cm (70,4 + 70,4 + 35,2 cm)	5210108	-	
45.0 cm deep	140,8 cm (70,4 + 35,2 + 35,2 cm) – as illustrated	5208208	-	
	176,0 cm (70,4 + 70,4 + 35,2 cm)	5210208	-	

3 Raster units / lowboards



Accessories and lamps:
see pages 25 and 97

<p>3 Raster units / lowboards 52.8 cm high (54.6 cm high incl. 1.8 cm high plinth adjusters), 33.0 or 45.0 cm deep</p> <p>Surcharges for ...</p> <p>... carcasses in price group II: see pages 98-101</p> <p>... fronts in Design Plain (A) in price group II: see pages 102-103</p> <p>... fronts in Design Rear-lacquered glass (B) see page 104</p> <p>... fronts in Design Slat (C): see page 105</p> <p>... fronts in Design Glass (D) – panel: see page 106</p> <p>... fronts in Design Glass (D) – veneer-covered aluminium frame: see page 106</p> <p>... drawers (instead of flaps): see page 106</p> <p>Important note: Cover shelves are essential and must be ordered separately (see pages 84-85)!</p> <p>When used as wall units or stacked units: Max. load 15 kg per metre: 35.2 cm width: 5.0 kg 52.8 cm width: 7.5 kg 70.4 cm width: 10.0 kg 105.6 cm width: 15.0 kg 123.2 cm width: 15.0 kg 140.8 cm width: 20.0 kg 158.4 cm width: 20.0 kg 176.0 cm width: 25.0 kg 193.6 cm width: 25.0 kg 211.2 cm width: 30.0 kg</p>	1 door in Design Plain (A)				
		Width	Type no.		Price group I
			Door hinge left	Door hinge right	
	33.0 cm deep	35,2 cm	5302101	5302102	-
		52,8 cm – as illustrated	5303101	5303102	-
		70,4 cm – 2 doors	5304101		-
		105,6 cm – 2 doors	5306101		-
	45.0 cm deep	35,2 cm	5302201	5302202	-
		52,8 cm – as illustrated	5303201	5303202	-
70,4 cm – 2 doors		5304201		-	
105,6 cm – 2 doors		5306201		-	
1 glass door in Design Glass (D)					
	Width	Type no.		Price group I	
		Door hinge left	Door hinge right		
33.0 cm deep	35,2 cm	5302161	5302162	-	
	52,8 cm – as illustrated	5303161	5303162	-	
	70,4 cm – 2 doors	5304161		-	
	105,6 cm – 2 doors	5306161		-	
45.0 cm deep	35,2 cm	5302261	5302262	-	
	52,8 cm – as illustrated	5303261	5303262	-	
	70,4 cm – 2 doors	5304261		-	
	105,6 cm – 2 doors	5306261		-	

Notes on delivery:
Please see here the information on range introduction pages.

Assembly notes for wall units:
Please be sure to note here the information and notes in the "Wall composition" chapter!

3 Raster units / lowboards

<p>3 Raster units / lowboards 52.8 cm high (54.6 cm high incl. 1.8 cm high plinth adjusters), 33.0 or 45.0 cm deep</p> <p>Surcharges for ...</p> <p>... carcasses in price group II: see pages 98-101</p> <p>... fronts in Design Plain (A) in price group II: see pages 102-103</p> <p>... fronts in Design Rear-lacquered glass (B) see page 104</p> <p>... fronts in Design Slat (C): see page 105</p> <p>... fronts in Design Glass (D) – panel: see page 106</p> <p>... fronts in Design Glass (D) – veneer-covered aluminium frame: see page 106</p> <p>... drawers (instead of flaps): see page 106</p> <p>Important note: Cover shelves are essential and must be ordered separately (see pages 84-85)!</p> <p>When used as wall units or stacked units: Max. load 15 kg per metre: 35.2 cm width: 5.0 kg 52.8 cm width: 7.5 kg 70.4 cm width: 10.0 kg 105.6 cm width: 15.0 kg 123.2 cm width: 15.0 kg 140.8 cm width: 20.0 kg 158.4 cm width: 20.0 kg 176.0 cm width: 25.0 kg 193.6 cm width: 25.0 kg 211.2 cm width: 30.0 kg</p>	<p>3 doors in Design Plain (A)</p>  <p style="text-align: right;">3</p>			
	<p>Width (individual unit widths)</p>		<p>Type no.</p>	<p>Price group I</p>
	<p>33.0 cm deep</p>	<p>158,4 cm (105,6 + 52,8 cm) – as illustrated</p>	<p>5309101</p>	<p>-</p>
	<p>45.0 cm deep</p>	<p>158,4 cm (105,6 + 52,8 cm) – as illustrated</p>	<p>5309201</p>	<p>-</p>
	<p>4 doors in Design Plain (A)</p>  <p style="text-align: right;">3</p>			
	<p>Width (individual unit widths)</p>		<p>Type no.</p>	<p>Price group I</p>
	<p>33.0 cm deep</p>	<p>140,8 cm (70,4 + 70,4 cm) – as illustrated 211,2 cm (105,6 + 105,6 cm)</p>	<p>5308101 5312101</p>	<p>- -</p>
	<p>45.0 cm deep</p>	<p>140,8 cm (70,4 + 70,4 cm) – as illustrated 211,2 cm (105,6 + 105,6 cm)</p>	<p>5308201 5312201</p>	<p>- -</p>

3 Raster units / lowboards

Accessories and lamps:
see pages 25 and 97

3 Raster units / lowboards
52.8 cm high
(54.6 cm high incl. 1.8 cm high plinth adjusters),
33.0 or 45.0 cm deep

Surcharges for ...

... carcasses in price group II:
see pages 98-101

... fronts in Design Plain (A) in price group II:
see pages 102-103

... fronts in Design Rear-lacquered glass (B)
see page 104

... fronts in Design Slat (C):
see page 105

... fronts in Design Glass (D) – panel:
see page 106

... fronts in Design Glass (D) – veneer-covered aluminium frame:
see page 106

... drawers (instead of flaps):
see page 106

1 flap in Design Plain (A)



	Width	Type no.	Price group I
33,0 cm deep	52,8 cm – as illustrated	5303103	-
	70,4 cm	5304103	-
	105,6 cm	5306103	-
45,0 cm deep	52,8 cm – as illustrated	5303203	-
	70,4 cm	5304203	-
	105,6 cm	5306203	-

2 flaps in Design Plain (A)



	Width (individual unit widths)	Type no.	Price group I
33,0 cm deep	140,8 cm (70,4 + 70,4 cm) – as illustrated	5308102	-
	211,2 cm (105,6 + 105,6 cm)	5312102	-
45,0 cm deep	140,8 cm (70,4 + 70,4 cm) – as illustrated	5308202	-
	211,2 cm (105,6 + 105,6 cm)	5312202	-

3 flaps in Design Plain (A)



	Width (individual unit widths)	Type no.	Price group I
33,0 cm deep	158,4 cm (52,8 + 52,8 + 52,8 cm) – as illustrated	3 5309103	-
	211,2 cm (70,4 + 70,4 + 70,4 cm)	4 5312103	-
45,0 cm deep	158,4 cm (52,8 + 52,8 + 52,8 cm) – as illustrated	3 5309203	-
	211,2 cm (70,4 + 70,4 + 70,4 cm)	4 5312203	-

Important note:
Cover shelves are essential and must be ordered separately (see pages 84-85)!

When used as wall units or stacked units:
Max. load 15 kg per metre:
35.2 cm width: 5.0 kg
52.8 cm width: 7.5 kg
70.4 cm width: 10.0 kg
105.6 cm width: 15.0 kg
123.2 cm width: 15.0 kg
140.8 cm width: 20.0 kg
158.4 cm width: 20.0 kg
176.0 cm width: 25.0 kg
193.6 cm width: 25.0 kg
211.2 cm width: 30.0 kg

Notes on delivery:
Please see here the information on range introduction pages.

Assembly notes for wall units:
Please be sure to note here the information and notes in the "Wall composition" chapter!

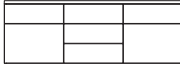

3 Raster units / lowboards

SPECTRUM

3 Raster units / lowboards		3 drawers in Design Plain (A)		
52.8 cm high (54.6 cm high incl. 1.8 cm high plinth adjusters), 33.0 or 45.0 cm deep				
		Width	Type no.	Price group I
Surcharges for ...	33.0 cm deep	35,2 cm	5302105	-
		52,8 cm – as illustrated	5303105	-
		70,4 cm	5304105	-
		105,6 cm	5306105	-
... carcasses in price group II: see pages 98-101	45.0 cm deep	35,2 cm	5302205	-
		52,8 cm – as illustrated	5303205	-
		70,4 cm	5304205	-
		105,6 cm	5306205	-
... fronts in Design Plain (A) in price group II: see pages 102-103				
... fronts in Design Rear-lacquered glass (B) see page 104				
... fronts in Design Slat (C): see page 105				
... fronts in Design Glass (D) – panel: see page 106				
... fronts in Design Glass (D) – veneer-covered aluminium frame: see page 106				
... drawers (instead of flaps): see page 106				
		5 drawers and 2 flaps in Design Plain (A)		
Important note: Cover shelves are essential and must be ordered separately (see pages 84-85)!				
		Width (individual unit widths)	Type no.	Price group I
33.0 cm deep	158,4 cm (52,8 + 52,8 + 52,8 cm) – as illustrated	3	5309106	-
	176,0 cm (52,8 + 70,4 + 52,8 cm)	4	5310106	-
	211,2 cm (70,4 + 70,4 + 70,4 cm)	4	5312106	-
45.0 cm deep	158,4 cm (52,8 + 52,8 + 52,8 cm) – as illustrated	3	5309206	-
	176,0 cm (52,8 + 70,4 + 52,8 cm)	4	5310206	-
	211,2 cm (70,4 + 70,4 + 70,4 cm)	4	5312206	-
When used as wall units or stacked units: Max. load 15 kg per metre: 35.2 cm width: 5.0 kg 52.8 cm width: 7.5 kg 70.4 cm width: 10.0 kg 105.6 cm width: 15.0 kg 123.2 cm width: 15.0 kg 140.8 cm width: 20.0 kg 158.4 cm width: 20.0 kg 176.0 cm width: 25.0 kg 193.6 cm width: 25.0 kg 211.2 cm width: 30.0 kg				

3 Raster units / lowboards

Accessories and lamps:
see pages 25 and 97

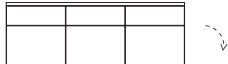
<p>3 Raster units / lowboards 52.8 cm high (54.6 cm high incl. 1.8 cm high plinth adjusters), 33.0 or 45.0 cm deep</p> <p>Surcharges for ...</p> <p>... carcasses in price group II: see pages 98-101</p> <p>... fronts in Design Plain (A) in price group II: see pages 102-103</p> <p>... fronts in Design Rear-lacquered glass (B) see page 104</p> <p>... fronts in Design Slat (C): see page 105</p> <p>... fronts in Design Glass (D) – panel: see page 106</p> <p>... fronts in Design Glass (D) – veneer-covered aluminium frame: see page 106</p> <p>... drawers (instead of flaps): see page 106</p>	1 drawer and 1 flap in Design Plain (A)			
				
		Width	Type no.	Price group I
	33.0 cm deep	35,2 cm	5302104	-
		52,8 cm – as illustrated	5303104	-
		70,4 cm	5304104	-
		105,6 cm	5306104	-
	45.0 cm deep	35,2 cm	5302204	-
		52,8 cm – as illustrated	5303204	-
		70,4 cm	5304204	-
105,6 cm		5306204	-	
2 drawers and 2 flaps in Design Plain (A)				
				
	Width (individual unit widths)	Type no.	Price group I	
33.0 cm deep	140,8 cm (70,4 + 70,4 cm) – as illustrated	5308104	-	
	211,2 cm (105,6 + 105,6 cm)	5312104	-	
45.0 cm deep	140,8 cm (70,4 + 70,4 cm) – as illustrated	5308204	-	
	211,2 cm (105,6 + 105,6 cm)	5312204	-	
3 drawers and 3 flaps in Design Plain (A)				
				
	Width (individual unit widths)	Type no.	Price group I	
33.0 cm deep	158,4 cm (52,8 + 52,8 + 52,8 cm) – as illustrated	3 5309105	-	
	211,2 cm (70,4 + 70,4 + 70,4 cm)	4 5312105	-	
	211,2 cm (52,8 + 105,6 + 52,8 cm)	4 5312111	-	
45.0 cm deep	158,4 cm (52,8 + 52,8 + 52,8 cm) – as illustrated	3 5309205	-	
	211,2 cm (70,4 + 70,4 + 70,4 cm)	4 5312205	-	
	211,2 cm (52,8 + 105,6 + 52,8 cm)	4 5312211	-	
Important note: Cover shelves are essential and must be ordered separately (see pages 84-85)!				
<p>When used as wall units or stacked units: Max. load 15 kg per metre: 35.2 cm width: 5.0 kg 52.8 cm width: 7.5 kg 70.4 cm width: 10.0 kg 105.6 cm width: 15.0 kg 123.2 cm width: 15.0 kg 140.8 cm width: 20.0 kg 158.4 cm width: 20.0 kg 176.0 cm width: 25.0 kg 193.6 cm width: 25.0 kg 211.2 cm width: 30.0 kg</p>				

Notes on delivery:
Please see here the information on range introduction pages.

Assembly notes for wall units:
Please be sure to note here the information and notes in the "Wall composition" chapter!

3 Raster units / lowboards

<p>3 Raster units / lowboards 52.8 cm high (54.6 cm high incl. 1.8 cm high plinth adjusters), 33.0 or 45.0 cm deep</p> <p>Surcharges for ...</p> <p>... carcasses in price group II: see pages 98-101</p> <p>... fronts in Design Plain (A) in price group II: see pages 102-103</p> <p>... fronts in Design Rear-lacquered glass (B) see page 104</p> <p>... fronts in Design Slat (C): see page 105</p> <p>... fronts in Design Glass (D) – panel: see page 106</p> <p>... fronts in Design Glass (D) – veneer-covered aluminium frame: see page 106</p> <p>... drawers (instead of flaps): see page 106</p>	2 doors, 1 drawer and 1 flap in Design Plain (A)			
		Width (individual unit widths)	Type no.	Price group I
	33.0 cm deep	140,8 cm (35,2 + 70,4 + 35,2 cm) – as illustrated	3	5308109
		211,2 cm (52,8 + 105,6 + 52,8 cm)	4	5312109
	45.0 cm deep	140,8 cm (35,2 + 70,4 + 35,2 cm) – as illustrated	3	5308209
		211,2 cm (52,8 + 105,6 + 52,8 cm)	4	5312209
	2 doors and 3 drawers in Design Plain (A)			
		Width (individual unit widths)	Type no.	Price group I
33.0 cm deep	140,8 cm (35,2 + 70,4 + 35,2 cm)	3	5308110	
	158,4 cm (52,8 + 52,8 + 52,8 cm) – as illustrated	4	5309110	
	176,0 cm (52,8 + 70,4 + 52,8 cm)	4	5310110	
	211,2 cm (52,8 + 105,6 + 52,8 cm)	4	5312110	
45.0 cm deep	140,8 cm (35,2 + 70,4 + 35,2 cm)	3	5308210	
	158,4 cm (52,8 + 52,8 + 52,8 cm) – as illustrated	4	5309210	
	176,0 cm (52,8 + 70,4 + 52,8 cm)	4	5310210	
	211,2 cm (52,8 + 105,6 + 52,8 cm)	4	5312210	
2 doors, 1 drawer and 1 flap in Design Plain (A)				
Important note: Cover shelves are essential and must be ordered separately (see pages 84-85)!				
	Width (individual unit widths)	Type no.	Price group I	
33.0 cm deep	211,2 cm (105,6 + 105,6 cm) – as illustrated	3	5312107	
45.0 cm deep	211,2 cm (105,6 + 105,6 cm) – as illustrated	3	5312207	
<p>When used as wall units or stacked units: Max. load 15 kg per metre: 35.2 cm width: 5.0 kg 52.8 cm width: 7.5 kg 70.4 cm width: 10.0 kg 105.6 cm width: 15.0 kg 123.2 cm width: 15.0 kg 140.8 cm width: 20.0 kg 158.4 cm width: 20.0 kg 176.0 cm width: 25.0 kg 193.6 cm width: 25.0 kg 211.2 cm width: 30.0 kg</p>				

3 Raster units / lowboards

Accessories and lamps:
see pages 25 and 97

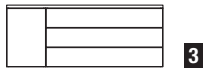
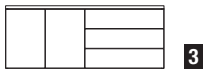
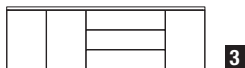
<p>3 Raster units / lowboards 52.8 cm high (54.6 cm high incl. 1.8 cm high plinth adjusters), 33.0 or 45.0 cm deep</p> <p>Surcharges for ...</p> <p>... carcasses in price group II: see pages 98-101</p> <p>... fronts in Design Plain (A) in price group II: see pages 102-103</p> <p>... fronts in Design Rear-lacquered glass (B) see page 104</p> <p>... fronts in Design Slat (C): see page 105</p> <p>... fronts in Design Glass (D) – panel: see page 106</p> <p>... fronts in Design Glass (D) – veneer-covered aluminium frame: see page 106</p> <p>... drawers (instead of flaps): see page 106</p> <p>Important note: Cover shelves are essential and must be ordered separately (see pages 84-85)!</p> <p>Mirror-image types are possible. Please add an „S“ to the type no. in this case.</p> <p>When used as wall units or stacked units: Max. load 15 kg per metre: 35.2 cm width: 5.0 kg 52.8 cm width: 7.5 kg 70.4 cm width: 10.0 kg 105.6 cm width: 15.0 kg 123.2 cm width: 15.0 kg 140.8 cm width: 20.0 kg 158.4 cm width: 20.0 kg 176.0 cm width: 25.0 kg 193.6 cm width: 25.0 kg 211.2 cm width: 30.0 kg</p>	<p>1 door and 3 drawers in Design Plain (A)</p> 			
		<p>Width (individual unit widths)</p>	<p>Type no.</p>	<p>Price group I</p>
	33.0 cm deep	140,8 cm (35,2 + 105,6 cm) – as illustrated	5308111	-
	45.0 cm deep	140,8 cm (35,2 + 105,6 cm) – as illustrated	5308211	-
	<p>2 doors and 3 drawers in Design Plain (A)</p> 			
		<p>Width (individual unit widths)</p>	<p>Type no.</p>	<p>Price group I</p>
	33.0 cm deep	140,8 cm (70,4 + 70,4 cm) – as illustrated 158,4 cm (105,6 + 52,8 cm) 176,0 cm (105,6 + 70,4 cm) 211,2 cm (105,6 + 105,6 cm)	5308108 5309108 5310108 5312108	- - - -
	45.0 cm deep	140,8 cm (70,4 + 70,4 cm) – as illustrated 158,4 cm (105,6 + 52,8 cm) 176,0 cm (105,6 + 70,4 cm) 211,2 cm (105,6 + 105,6 cm)	5308208 5309208 5310208 5312208	- - - -
	<p>3 doors and 3 drawers in Design Plain (A)</p> 			
		<p>Width (individual unit widths)</p>	<p>Type no.</p>	<p>Price group I</p>
33.0 cm deep	176,0 cm (70,4 + 70,4 + 35,2 cm) – as illustrated	5310101	-	
45.0 cm deep	176,0 cm (70,4 + 70,4 + 35,2 cm) – as illustrated	5310201	-	

Flat screen supports

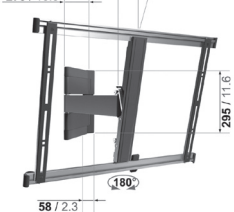
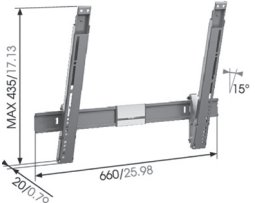
<p>Flat screen support WTL6 The flat screen support can be adjusted 3-dimensionally. It is suitable for flat screens with a screen diagonal of 102-216 cm (40"-85"); max. load: 45 kg. Suitable for Curved TV's. Flat screen support compatible with VESA Norm standard: min.: 200 x 200 mm max.: 600 x 400 mm</p> 	<p>Flat screen support THIN 545, ideally adaptable The flat screen support can be adjusted 3-dimensionally. It is suitable for flat screens with a screen diagonal of 102-165 cm (40"-65") and a maximum depth of 4.5 cm; max. load: 25 kg. Go to www.vogels.com to check if your flat screen can be fitted on this flat screen support. Enter the name THIN 545. After a few steps you can see if your flat screen TV is compatible with the flat screen support. Not suitable for Curved TV's. Flat screen support compatible with VESA Norm standard: min.: 100 x 100 mm max.: 600 x 400 mm</p> 	<p>Flat screen support THIN 515 The flat screen support can be angled up to a max. 15°. It is suitable for flat screens with a screen diagonal of 102-165 cm (40"-65") and a maximum depth of 5.0 cm; max. load: 25 kg. Go to www.vogels.com to check if your flat screen can be fitted on this flat screen support. Enter the name THIN 515. After a few steps you can see if your flat screen TV is compatible with the flat screen support. Not suitable for Curved TV's. Flat screen support compatible with VESA Norm standard: min.: 100 x 100 mm max.: 600 x 400 mm</p> 
<p>for fitting anywhere on walls</p>	<p>for fitting anywhere on walls</p>	<p>for fitting anywhere on walls</p>
<p>9704 -</p>	<p>9304 -</p>	<p>9504 -</p>

Cable apertures

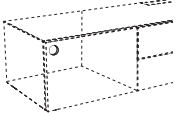
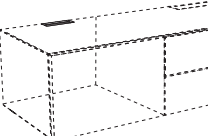
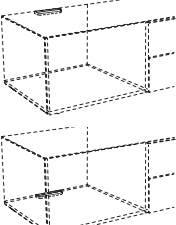
	<p>Cable aperture K2 silver-coloured; Ø 8.0 cm It is possible to fit a cable aperture in the rear wall of the lowboard. Positioned in centre of compartment.</p>	<p>K2 -</p>
	<p>Cable aperture K8 silver-coloured; 12.8 x 3.2 cm It is possible to fit a cable aperture in the top shelf of the lowboard. The cable aperture can be made at the rear rim of the top shelf. Positioned in centre of compartment.</p>	<p>K8 -</p>
	<p>Cable aperture K9 13.0 x 1.6 cm It is possible to fit a cable aperture in the top or bottom shelf. The cable aperture can be made at the rear rim of the top or bottom shelf behind the rear wall. Positioned in centre of compartment.</p>	<p>K9 -</p>

4 Raster units / sideboards

Lamps: see page 97

<p>4 Raster units / sideboards 70.4 cm high (72.2 cm high incl. 1.8 cm high plinth adjusters), 33.0 or 45.0 cm deep</p> <p>Surcharges for ...</p> <p>... carcasses in price group II: see pages 98-101</p> <p>... fronts in Design Plain (A) in price group II: see pages 102-103</p> <p>... fronts in Design Rear-lacquered glass (B) see page 104</p> <p>... fronts in Design Slat (C): see page 105</p> <p>... fronts in Design Glass (D) – panel: see page 106</p> <p>... fronts in Design Glass (D) – veneer-covered aluminium frame: see page 106</p> <p>... drawers (instead of flaps): see page 106</p> <p>Important note: Cover shelves are essential and must be ordered separately (see pages 84-85)!</p>	1 door in Design Plain (A)							
			Width		Type no.		Price group I	
					Door hinge left	Door hinge right		
	33.0 cm deep	35,2 cm			5402101	5402102	-	
		52,8 cm – as illustrated			5403101	5403102	-	
		70,4 cm – 2 doors			5404101		-	
		105,6 cm – 2 doors			5406101		-	
	45.0 cm deep	35,2 cm			5402201	5402202	-	
		52,8 cm – as illustrated			5403201	5403202	-	
70,4 cm – 2 doors				5404201		-		
105,6 cm – 2 doors				5406201		-		
				1 glass door in Design Glass (D)				
		Width		Type no.		Price group I		
				Door hinge left	Door hinge right			
33.0 cm deep	35,2 cm			5402161	5402162	-		
	52,8 cm – as illustrated			5403161	5403162	-		
	70,4 cm – 2 doors			5404161		-		
	105,6 cm – 2 doors			5406161		-		
45.0 cm deep	35,2 cm			5402261	5402262	-		
	52,8 cm – as illustrated			5403261	5403262	-		
	70,4 cm – 2 doors			5404261		-		
	105,6 cm – 2 doors			5406261		-		
				2 doors in Design Plain (A) and 2 glass doors in Design Glass (D)				
		Width (individual unit widths)		Type no.		Price group I		
33.0 cm deep	211,2 cm (52,8 + 105,6 + 52,8 cm) – as illustrated		5412162		-			
45.0 cm deep	211,2 cm (52,8 + 105,6 + 52,8 cm) – as illustrated		5412262		-			

When used as wall units or stacked units:
Max. load per unit: 40 kg

Notes on delivery:
Please see here the information on range introduction pages.

Assembly notes for wall units:
Please be sure to note here the information and notes in the "Wall composition" chapter!

4 Raster units / sideboards

SPECTRUM



<p>4 Raster units / sideboards 70.4 cm high (72.2 cm high incl. 1.8 cm high plinth adjusters), 33.0 or 45.0 cm deep</p> <p>Surcharges for ...</p> <p>... carcasses in price group II: see pages 98-101</p> <p>... fronts in Design Plain (A) in price group II: see pages 102-103</p> <p>... fronts in Design Rear-lacquered glass (B) see page 104</p> <p>... fronts in Design Slat (C): see page 105</p> <p>... fronts in Design Glass (D) – panel: see page 106</p> <p>... fronts in Design Glass (D) – veneer-covered aluminium frame: see page 106</p> <p>... drawers (instead of flaps): see page 106</p>	3 doors in Design Plain (A)			
	3			
		Width (individual unit widths)	Type no.	Price group I
	33,0 cm deep	158,4 cm (105,6 + 52,8 cm) – as illustrated	5409101	-
	45,0 cm deep	158,4 cm (105,6 + 52,8 cm) – as illustrated	5409201	-
	3 glass doors in Design Glass (D)			
	3			
		Width (individual unit widths)	Type no.	Price group I
33,0 cm deep	158,4 cm (105,6 + 52,8 cm) – as illustrated	5409161	-	
45,0 cm deep	158,4 cm (105,6 + 52,8 cm) – as illustrated	5409261	-	
4 doors in Design Plain (A)				
3				
	Width (individual unit widths)	Type no.	Price group I	
33,0 cm deep	140,8 cm (70,4 + 70,4 cm) – as illustrated 211,2 cm (105,6 + 105,6 cm)	5408101 5412101	- -	
45,0 cm deep	140,8 cm (70,4 + 70,4 cm) – as illustrated 211,2 cm (105,6 + 105,6 cm)	5408201 5412201	- -	
4 glass doors in Design Glass (D)				
3				
	Width (individual unit widths)	Type no.	Price group I	
33,0 cm deep	140,8 cm (70,4 + 70,4 cm) – as illustrated 211,2 cm (105,6 + 105,6 cm)	5408161 5412161	- -	
45,0 cm deep	140,8 cm (70,4 + 70,4 cm) – as illustrated 211,2 cm (105,6 + 105,6 cm)	5408261 5412261	- -	

Important note:
Cover shelves are essential and must be ordered separately (see pages 84-85)!

When used as wall units or stacked units:
Max. load per unit: 40 kg

4 Raster units / sideboards

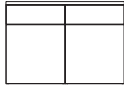
Lamps: see page 97

<p>4 Raster units / sideboards 70.4 cm high (72.2 cm high incl. 1.8 cm high plinth adjusters), 33.0 or 45.0 cm deep</p> <p>Surcharges for ...</p> <p>... carcasses in price group II: see pages 98-101</p> <p>... fronts in Design Plain (A) in price group II: see pages 102-103</p> <p>... fronts in Design Rear-lacquered glass (B) see page 104</p> <p>... fronts in Design Slat (C): see page 105</p> <p>... fronts in Design Glass (D) – panel: see page 106</p> <p>... fronts in Design Glass (D) – veneer-covered aluminium frame: see page 106</p> <p>... drawers (instead of flaps): see page 106</p>	1 drawer and 1 door in Design Plain (A)			
				
			Type no.	
			Price group I	
		Width	Door hinge left	Door hinge right
	33.0 cm deep	35,2 cm	5402103	5402104
		52,8 cm – as illustrated	5403103	5403104
		70,4 cm – 2 doors	5404103	
		105,6 cm – 2 doors	5406103	
	45.0 cm deep	35,2 cm	5402203	5402204
52,8 cm – as illustrated		5403203	5403204	
70,4 cm – 2 doors		5404203		
105,6 cm – 2 doors		5406203		
2 drawers and 2 doors in Design Plain (A)				
				
		Type no.		
		Price group I		
	Width (individual unit widths)			
33.0 cm deep	105,6 cm (52,8 + 52,8 cm) – as illustrated	5406110		
45.0 cm deep	105,6 cm (52,8 + 52,8 cm) – as illustrated	5406210		
3 drawers and 3 doors in Design Plain (A)				
				
		Type no.		
		Price group I		
	Width (individual unit widths)			
33.0 cm deep	158,4 cm (52,8 + 52,8 + 52,8 cm) – as illustrated	5409102		
45.0 cm deep	158,4 cm (52,8 + 52,8 + 52,8 cm) – as illustrated	5409202		
2 drawers and 4 doors in Design Plain (A)				
				
		Type no.		
		Price group I		
	Width (individual unit widths)			
33.0 cm deep	140,8 cm (70,4 + 70,4 cm) – as illustrated	5408104		
	211,2 cm (105,6 + 105,6 cm)	5412104		
45.0 cm deep	140,8 cm (70,4 + 70,4 cm) – as illustrated	5408204		
	211,2 cm (105,6 + 105,6 cm)	5412204		

Important note:
Cover shelves are essential and must be ordered separately (see pages 84-85)!

When used as wall units or stacked units:
Max. load per unit: 40 kg

Notes on delivery:
Please see here the information on range introduction pages.

Assembly notes for wall units:
Please be sure to note here the information and notes in the "Wall composition" chapter!

4 Raster units / sideboards

SPECTRUM

4 Raster units / sideboards 70.4 cm high (72.2 cm high incl. 1.8 cm high plinth adjusters), 33.0 or 45.0 cm deep		4 drawers in Design Plain (A)				
<p>Surcharges for ...</p> <p>... carcasses in price group II: see pages 98-101</p> <p>... fronts in Design Plain (A) in price group II: see pages 102-103</p> <p>... fronts in Design Rear-lacquered glass (B) see page 104</p> <p>... fronts in Design Slat (C): see page 105</p> <p>... fronts in Design Glass (D) – panel: see page 106</p> <p>... fronts in Design Glass (D) – veneer-covered aluminium frame: see page 106</p> <p>... drawers (instead of flaps): see page 106</p>						
		Width	Type no.	Price group I		
		33.0 cm deep	35,2 cm	5402107	-	
			52,8 cm – as illustrated	5403107	-	
			70,4 cm	5404107	-	
			105,6 cm	5406107	-	
		45.0 cm deep	35,2 cm	5402207	-	
			52,8 cm – as illustrated	5403207	-	
			70,4 cm	5404207	-	
			105,6 cm	5406207	-	
		<p>Important note: Cover shelves are essential and must be ordered separately (see pages 84-85)!</p>		2 drawers and 1 flap in Design Plain (A)		
Width	Type no.			Price group I		
33.0 cm deep	35,2 cm			5402106	-	
	52,8 cm – as illustrated			5403106	-	
	70,4 cm			5404106	-	
	105,6 cm			5406106	-	
45.0 cm deep	35,2 cm			5402206	-	
	52,8 cm – as illustrated			5403206	-	
	70,4 cm			5404206	-	
	105,6 cm			5406206	-	
<p>Important note: Cover shelves are essential and must be ordered separately (see pages 84-85)!</p>				2 flaps in Design Plain (A)		
		Width	Type no.	Price group I		
		33.0 cm deep	35,2 cm	5402105	-	
			52,8 cm – as illustrated	5403105	-	
			70,4 cm	5404105	-	
			105,6 cm	5406105	-	
		45.0 cm deep	35,2 cm	5402205	-	
			52,8 cm – as illustrated	5403205	-	
			70,4 cm	5404205	-	
			105,6 cm	5406205	-	
		<p>Important note: Cover shelves are essential and must be ordered separately (see pages 84-85)!</p>		4 flaps in Design Plain (A)		
Width (individual unit widths)	Type no.			Price group I		
33.0 cm deep	105,6 cm (52,8 + 52,8 cm)			5406109	-	
	140,8 cm (70,4 + 70,4 cm) – as illustrated			5408103	-	
	211,2 cm (105,6 + 105,6 cm)			5412103	-	
45.0 cm deep	105,6 cm (52,8 + 52,8 cm)			5406209	-	
	140,8 cm (70,4 + 70,4 cm) – as illustrated			5408203	-	
	211,2 cm (105,6 + 105,6 cm)			5412203	-	

When used as wall units or stacked units:
Max. load per unit: 40 kg

<p>4 Raster units / sideboards 70.4 cm high (72.2 cm high incl. 1.8 cm high plinth adjusters), 33.0 or 45.0 cm deep</p> <p>Surcharges for ...</p> <p>... carcasses in price group II: see pages 98-101</p> <p>... fronts in Design Plain (A) in price group II: see pages 102-103</p> <p>... fronts in Design Rear-lacquered glass (B) see page 104</p> <p>... fronts in Design Slat (C): see page 105</p> <p>... fronts in Design Glass (D) – panel: see page 106</p> <p>... fronts in Design Glass (D) – veneer-covered aluminium frame: see page 106</p> <p>... drawers (instead of flaps): see page 106</p>	6 drawers and 2 doors in Design Plain (A)				
		Width (individual unit widths)	Type no.	Price group I	
	33.0 cm deep	123,2 cm (35,2 + 52,8 + 35,2 cm)	3	5407105	-
		140,8 cm (35,2 + 70,4 + 35,2 cm) – as illustrated	3	5408105	-
		158,4 cm (52,8 + 52,8 + 52,8 cm)	3	5409105	-
		176,0 cm (52,8 + 70,4 + 52,8 cm)	4	5410105	-
		211,2 cm (52,8 + 105,6 + 52,8 cm)	4	5412105	-
	45.0 cm deep	123,2 cm (35,2 + 52,8 + 35,2 cm)	3	5407205	-
		140,8 cm (35,2 + 70,4 + 35,2 cm) – as illustrated	3	5408205	-
158,4 cm (52,8 + 52,8 + 52,8 cm)		3	5409205	-	
176,0 cm (52,8 + 70,4 + 52,8 cm)		4	5410205	-	
211,2 cm (52,8 + 105,6 + 52,8 cm)		4	5412205	-	
6 drawers in Design Plain (A) and 2 glass doors in Design Glass (D)					
	Width (individual unit widths)	Type no.	Price group I		
33.0 cm deep	123,2 cm (35,2 + 52,8 + 35,2 cm)	3	5407165	-	
	140,8 cm (35,2 + 70,4 + 35,2 cm) – as illustrated	3	5408165	-	
	158,4 cm (52,8 + 52,8 + 52,8 cm)	3	5409165	-	
	176,0 cm (52,8 + 70,4 + 52,8 cm)	4	5410165	-	
	211,2 cm (52,8 + 105,6 + 52,8 cm)	4	5412165	-	
45.0 cm deep	123,2 cm (35,2 + 52,8 + 35,2 cm)	3	5407265	-	
	140,8 cm (35,2 + 70,4 + 35,2 cm) – as illustrated	3	5408265	-	
	158,4 cm (52,8 + 52,8 + 52,8 cm)	3	5409265	-	
	176,0 cm (52,8 + 70,4 + 52,8 cm)	4	5410265	-	
	211,2 cm (52,8 + 105,6 + 52,8 cm)	4	5412265	-	
2 doors and 2 flaps in Design Plain (A)					
	Width (individual unit widths)	Type no.	Price group I		
33.0 cm deep	123,2 cm (35,2 + 52,8 + 35,2 cm)	3	5407109	-	
	140,8 cm (35,2 + 70,4 + 35,2 cm) – as illustrated	3	5408109	-	
	158,4 cm (52,8 + 52,8 + 52,8 cm)	3	5409109	-	
	176,0 cm (52,8 + 70,4 + 52,8 cm)	4	5410109	-	
	211,2 cm (52,8 + 105,6 + 52,8 cm)	4	5412109	-	
45.0 cm deep	123,2 cm (35,2 + 52,8 + 35,2 cm)	3	5407209	-	
	140,8 cm (35,2 + 70,4 + 35,2 cm) – as illustrated	3	5408209	-	
	158,4 cm (52,8 + 52,8 + 52,8 cm)	3	5409209	-	
	176,0 cm (52,8 + 70,4 + 52,8 cm)	4	5410209	-	
	211,2 cm (52,8 + 105,6 + 52,8 cm)	4	5412209	-	
2 glass doors in Design Glass (D) and 2 flaps in Design Plain (A)					
	Width (individual unit widths)	Type no.	Price group I		
33.0 cm deep	123,2 cm (35,2 + 52,8 + 35,2 cm)	3	5407169	-	
	140,8 cm (35,2 + 70,4 + 35,2 cm) – as illustrated	3	5408169	-	
	158,4 cm (52,8 + 52,8 + 52,8 cm)	3	5409169	-	
	176,0 cm (52,8 + 70,4 + 52,8 cm)	4	5410169	-	
	211,2 cm (52,8 + 105,6 + 52,8 cm)	4	5412169	-	
45.0 cm deep	123,2 cm (35,2 + 52,8 + 35,2 cm)	3	5407269	-	
	140,8 cm (35,2 + 70,4 + 35,2 cm) – as illustrated	3	5408269	-	
	158,4 cm (52,8 + 52,8 + 52,8 cm)	3	5409269	-	
	176,0 cm (52,8 + 70,4 + 52,8 cm)	4	5410269	-	
	211,2 cm (52,8 + 105,6 + 52,8 cm)	4	5412269	-	

Important note:
Cover shelves are essential and must be ordered separately (see pages 84-85)!

When used as wall units or stacked units:
Max. load per unit: 40 kg

Notes on delivery:
Please see here the information on range introduction pages.

T



Assembly notes for wall units:
Please be sure to note here the information and notes in the "Wall composition" chapter!

3

4

4 Raster units / sideboards

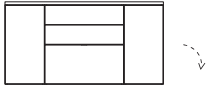
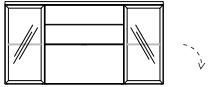
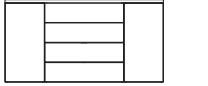

SPECTRUM

<p>4 Raster units / sideboards 70.4 cm high (72.2 cm high incl. 1.8 cm high plinth adjusters), 33.0 or 45.0 cm deep</p> <p>Surcharges for ...</p> <p>... carcasses in price group II: see pages 98-101</p> <p>... fronts in Design Plain (A) in price group II: see pages 102-103</p> <p>... fronts in Design Rear-lacquered glass (B) see page 104</p> <p>... fronts in Design Slat (C): see page 105</p> <p>... fronts in Design Glass (D) – panel: see page 106</p> <p>... fronts in Design Glass (D) – veneer-covered aluminium frame: see page 106</p> <p>... drawers (instead of flaps): see page 106</p>	2 doors, 2 drawers and 1 flap in Design Plain (A)				
					
	Width (individual unit widths)				
	Type no.				
	Price group I				
	33.0 cm deep	123,2 cm (35,2 + 52,8 + 35,2 cm)	3	5407110	-
		140,8 cm (35,2 + 70,4 + 35,2 cm) – as illustrated	3	5408110	-
		158,4 cm (52,8 + 52,8 + 52,8 cm)	3	5409110	-
		176,0 cm (52,8 + 70,4 + 52,8 cm)	4	5410110	-
		211,2 cm (52,8 + 105,6 + 52,8 cm)	4	5412110	-
45.0 cm deep	123,2 cm (35,2 + 52,8 + 35,2 cm)	3	5407210	-	
	140,8 cm (35,2 + 70,4 + 35,2 cm) – as illustrated	3	5408210	-	
	158,4 cm (52,8 + 52,8 + 52,8 cm)	3	5409210	-	
	176,0 cm (52,8 + 70,4 + 52,8 cm)	4	5410210	-	
	211,2 cm (52,8 + 105,6 + 52,8 cm)	4	5412210	-	
2 glass doors in Design Glass (D) as well as 2 drawers and 1 flap in Design Plain (A)					
					
Width (individual unit widths)					
Type no.					
Price group I					
33.0 cm deep	123,2 cm (35,2 + 52,8 + 35,2 cm)	3	5407170	-	
	140,8 cm (35,2 + 70,4 + 35,2 cm) – as illustrated	3	5408170	-	
	158,4 cm (52,8 + 52,8 + 52,8 cm)	3	5409170	-	
	176,0 cm (52,8 + 70,4 + 52,8 cm)	4	5410170	-	
	211,2 cm (52,8 + 105,6 + 52,8 cm)	4	5412170	-	
45.0 cm deep	123,2 cm (35,2 + 52,8 + 35,2 cm)	3	5407270	-	
	140,8 cm (35,2 + 70,4 + 35,2 cm) – as illustrated	3	5408270	-	
	158,4 cm (52,8 + 52,8 + 52,8 cm)	3	5409270	-	
	176,0 cm (52,8 + 70,4 + 52,8 cm)	4	5410270	-	
	211,2 cm (52,8 + 105,6 + 52,8 cm)	4	5412270	-	
2 doors and 4 drawers in Design Plain (A)					
					
Width (individual unit widths)					
Type no.					
Price group I					
33.0 cm deep	123,2 cm (35,2 + 52,8 + 35,2 cm)	3	5407111	-	
	140,8 cm (35,2 + 70,4 + 35,2 cm) – as illustrated	3	5408111	-	
	158,4 cm (52,8 + 52,8 + 52,8 cm)	3	5409111	-	
	176,0 cm (52,8 + 70,4 + 52,8 cm)	4	5410111	-	
	211,2 cm (52,8 + 105,6 + 52,8 cm)	4	5412111	-	
	211,2 cm (70,4 + 70,4 + 70,4 cm)	4	5412112	-	
45.0 cm deep	123,2 cm (35,2 + 52,8 + 35,2 cm)	3	5407211	-	
	140,8 cm (35,2 + 70,4 + 35,2 cm) – as illustrated	3	5408211	-	
	158,4 cm (52,8 + 52,8 + 52,8 cm)	3	5409211	-	
	176,0 cm (52,8 + 70,4 + 52,8 cm)	4	5410211	-	
	211,2 cm (52,8 + 105,6 + 52,8 cm)	4	5412211	-	
	211,2 cm (70,4 + 70,4 + 70,4 cm)	4	5412212	-	
2 glass doors in Design Glass (D) and 4 drawers in Design Plain (A)					
					
Width (individual unit widths)					
Type no.					
Price group I					
33.0 cm deep	123,2 cm (35,2 + 52,8 + 35,2 cm)	3	5407171	-	
	140,8 cm (35,2 + 70,4 + 35,2 cm) – as illustrated	3	5408171	-	
	158,4 cm (52,8 + 52,8 + 52,8 cm)	3	5409171	-	
	176,0 cm (52,8 + 70,4 + 52,8 cm)	4	5410171	-	
	211,2 cm (52,8 + 105,6 + 52,8 cm)	4	5412171	-	
45.0 cm deep	123,2 cm (35,2 + 52,8 + 35,2 cm)	3	5407271	-	
	140,8 cm (35,2 + 70,4 + 35,2 cm) – as illustrated	3	5408271	-	
	158,4 cm (52,8 + 52,8 + 52,8 cm)	3	5409271	-	
	176,0 cm (52,8 + 70,4 + 52,8 cm)	4	5410271	-	
	211,2 cm (52,8 + 105,6 + 52,8 cm)	4	5412271	-	

When used as wall units or stacked units:
Max. load per unit: 40 kg

4 Raster units / sideboards

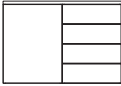
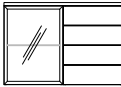
Lamps: see page 97

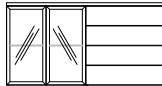
<p>4 Raster units / sideboards 70.4 cm high (72.2 cm high incl. 1.8 cm high plinth adjusters), 33.0 or 45.0 cm deep</p> <p>Surcharges for ...</p> <p>... carcasses in price group II: see pages 98-101</p> <p>... fronts in Design Plain (A) in price group II: see pages 102-103</p> <p>... fronts in Design Rear-lacquered glass (B) see page 104</p> <p>... fronts in Design Slat (C): see page 105</p> <p>... fronts in Design Glass (D) – panel: see page 106</p> <p>... fronts in Design Glass (D) – veneer-covered aluminium frame: see page 106</p> <p>... drawers (instead of flaps): see page 106</p> <p>Important note: Cover shelves are essential and must be ordered separately (see pages 84-85)!</p> <p>Mirror-image types are possible. Please add an „S“ to the type no. in this case.</p>	<p>1 door and 4 drawers in Design Plain (A)</p> 			
		<p>Width (individual unit widths)</p>	<p>Type no.</p>	<p>Price group I</p>
	33,0 cm deep	105,6 cm (52,8 + 52,8 cm) – as illustrated	5406111	-
	45,0 cm deep	105,6 cm (52,8 + 52,8 cm) – as illustrated	5406211	-
	<p>1 glass door in Design Glass (D) and 4 drawers in Design Plain (A)</p> 			
		<p>Width (individual unit widths)</p>	<p>Type no.</p>	<p>Price group I</p>
	33,0 cm deep	105,6 cm (52,8 + 52,8 cm) – as illustrated	5406171	-
	45,0 cm deep	105,6 cm (52,8 + 52,8 cm) – as illustrated	5406271	-
	<p>2 doors and 4 drawers in Design Plain (A)</p> 			
		<p>Width (individual unit widths)</p>	<p>Type no.</p>	<p>Price group I</p>
33,0 cm deep	140,8 cm (70,4 + 70,4 cm) – as illustrated 158,4 cm (105,6 + 52,8 cm) 211,2 cm (105,6 + 105,6 cm)	5408106 5409106 5412106	- - -	
45,0 cm deep	140,8 cm (70,4 + 70,4 cm) – as illustrated 158,4 cm (105,6 + 52,8 cm) 211,2 cm (105,6 + 105,6 cm)	5408206 5409206 5412206	- - -	
<p>2 glass doors in Design Glass (D) and 4 drawers in Design Plain (A)</p> 				
	<p>Width (individual unit widths)</p>	<p>Type no.</p>	<p>Price group I</p>	
33,0 cm deep	140,8 cm (70,4 + 70,4 cm) – as illustrated 158,4 cm (105,6 + 52,8 cm) 211,2 cm (105,6 + 105,6 cm)	5408166 5409166 5412166	- - -	
45,0 cm deep	140,8 cm (70,4 + 70,4 cm) – as illustrated 158,4 cm (105,6 + 52,8 cm) 211,2 cm (105,6 + 105,6 cm)	5408266 5409266 5412266	- - -	

When used as wall units or stacked units:
Max. load per unit: 40 kg

Notes on delivery:
Please see here the information on range introduction pages.

Assembly notes for wall units:
Please be sure to note here the information and notes in the "Wall composition" chapter!

4 Raster units / sideboards

4 Raster units / sideboards
70.4 cm high
(72.2 cm high incl. 1.8 cm high plinth adjusters),
33.0 or 45.0 cm deep

Surcharges for ...

... carcasses in price group II:
see pages 98-101

... fronts in Design Plain (A) in price group II:
see pages 102-103

... fronts in Design Rear-lacquered glass (B)
see page 104

... fronts in Design Slat (C):
see page 105

... fronts in Design Glass (D) – panel:
see page 106

... fronts in Design Glass (D) – veneer-covered aluminium frame:
see page 106



... drawers (instead of flaps):
see page 106

Important note:
Cover shelves are essential and must be ordered separately (see pages 84-85)!

Mirror-image types are possible. Please add an „S“ to the type no. in this case.

When used as wall units or stacked units:
Max. load per unit: 40 kg

3 doors and 4 drawers in Design Plain (A)			
			3
	Width (individual unit widths)	Type no.	Price group I
33.0 cm deep	140,8 cm (70,4 + 35,2 + 35,2 cm) – as illustrated	5408107	-
	176,0 cm (70,4 + 70,4 + 35,2 cm)	5410107	-
	211,2 cm (105,6 + 52,8 + 52,8 cm)	5412107	-
45.0 cm deep	140,8 cm (70,4 + 35,2 + 35,2 cm) – as illustrated	5408207	-
	176,0 cm (70,4 + 70,4 + 35,2 cm)	5410207	-
	211,2 cm (105,6 + 52,8 + 52,8 cm)	5412207	-
4 doors and 4 drawers in Design Plain (A)			
	Width (individual unit widths)	Type no.	Price group I
33.0 cm deep	176,0 cm (70,4 + 35,2 + 70,4 cm) – as illustrated	3 5410108	-
	193,6 cm (70,4 + 52,8 + 70,4 cm)	4 5411108	-
	211,2 cm (70,4 + 70,4 + 70,4 cm)	4 5412108	-
45.0 cm deep	176,0 cm (70,4 + 35,2 + 70,4 cm) – as illustrated	3 5410208	-
	193,6 cm (70,4 + 52,8 + 70,4 cm)	4 5411208	-
	211,2 cm (70,4 + 70,4 + 70,4 cm)	4 5412208	-

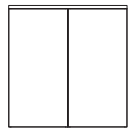
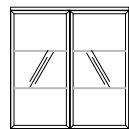
<p>6 Raster units / highboards 105.6 cm high (107.4 cm high incl. 1.8 cm high plinth adjusters), 33.0 or 45.0 cm deep</p> <p>Surcharges for ...</p> <p>... carcasses in price group II: see pages 98-101</p> <p>... fronts in Design Plain (A) in price group II: see pages 102-103</p> <p>... fronts in Design Rear-lacquered glass (B) see page 104</p> <p>... fronts in Design Slat (C): see page 105</p> <p>... fronts in Design Glass (D) – panel: see page 106</p> <p>... fronts in Design Glass (D) – veneer-covered aluminium frame: see page 106</p> <p>... drawers (instead of flaps): see page 106</p>	<p>1 door in Design Plain (A)</p> 				
		Width	Type no.		Price group I
			Door hinge left	Door hinge right	
	33.0 cm deep	35,2 cm	5502101	5502102	-
		52,8 cm – as illustrated	5503101	5503102	-
		70,4 cm	5504101	5504102	-
	45.0 cm deep	35,2 cm	5502201	5502202	-
		52,8 cm – as illustrated	5503201	5503202	-
		70,4 cm	5504201	5504202	-
	<p>1 glass door in Design Glass (D)</p> 				
	Width	Type no.		Price group I	
		Door hinge left	Door hinge right		
33.0 cm deep	35,2 cm	5502161	5502162	-	
	52,8 cm – as illustrated	5503161	5503162	-	
	70,4 cm	5504161	5504162	-	
45.0 cm deep	35,2 cm	5502261	5502262	-	
	52,8 cm – as illustrated	5503261	5503262	-	
	70,4 cm	5504261	5504262	-	
<p>2 doors in Design Plain (A)</p> 					
	Width (individual unit widths)	Type no.		Price group I	
33.0 cm deep	70,4 cm	5504103		-	
	105,6 cm – as illustrated	5506103		-	
	140,8 cm (70,4 + 70,4 cm)	5508103		-	
45.0 cm deep	70,4 cm	5504203		-	
	105,6 cm – as illustrated	5506203		-	
	140,8 cm (70,4 + 70,4 cm)	5508203		-	
<p>2 glass doors in Design Glass (D)</p> 					
	Width (individual unit widths)	Type no.		Price group I	
33.0 cm deep	70,4 cm	5504163		-	
	105,6 cm – as illustrated	5506163		-	
45.0 cm deep	70,4 cm	5504263		-	
	105,6 cm – as illustrated	5506263		-	

When used as wall units or stacked units:
Max. load per unit: 40 kg

Notes on delivery:
Please see here the information on range introduction pages.

Assembly notes for wall units:
Please be sure to note here the information and notes in the "Wall composition" chapter!

6 Raster units / highboards

<p>6 Raster units / highboards 105.6 cm high (107.4 cm high incl. 1.8 cm high plinth adjusters), 33.0 or 45.0 cm deep</p> <p>Surcharges for ...</p> <p>... carcasses in price group II: see pages 98-101</p> <p>... fronts in Design Plain (A) in price group II: see pages 102-103</p> <p>... fronts in Design Rear-lacquered glass (B) see page 104</p> <p>... fronts in Design Slat (C): see page 105</p> <p>... fronts in Design Glass (D) – panel: see page 106</p> <p>... fronts in Design Glass (D) – veneer-covered aluminium frame: see page 106</p> <p>... drawers (instead of flaps): see page 106</p> <p>Important note: Cover shelves are essential and must be ordered separately (see pages 84-85)!</p>	3 doors in Design Plain (A)			
		Width (individual unit widths)	Type no.	Price group I
	33,0 cm deep	158,4 cm (105,6 + 52,8 cm) – as illustrated	5509101	-
	45,0 cm deep	158,4 cm (105,6 + 52,8 cm) – as illustrated	5509201	-
	4 doors in Design Plain (A)			
		Width (individual unit widths)	Type no.	Price group I
	33,0 cm deep	140,8 cm (70,4 + 70,4 cm) 211,2 cm (105,6 + 105,6 cm) – as illustrated	5508102 5512102	- -
	45,0 cm deep	140,8 cm (70,4 + 70,4 cm) 211,2 cm (105,6 + 105,6 cm) – as illustrated	5508202 5512202	- -
2 glass doors in Design Glass (D) and 4 doors in Design Plain (A)				
	Width (individual unit widths)	Type no.	Price group I	
33,0 cm deep	211,2 cm (52,8 + 105,6 + 52,8 cm) – as illustrated	5512162	-	
45,0 cm deep	211,2 cm (52,8 + 105,6 + 52,8 cm) – as illustrated	5512262	-	

When used as wall units or stacked units:
Max. load per unit: 40 kg

6 Raster units / highboards

Lamps: see page 97

<p>6 Raster units / highboards 105.6 cm high (107.4 cm high incl. 1.8 cm high plinth adjusters), 33.0 or 45.0 cm deep</p> <p>Surcharges for ...</p> <p>... carcasses in price group II: see pages 98-101</p> <p>... fronts in Design Plain (A) in price group II: see pages 102-103</p> <p>... fronts in Design Rear-lacquered glass (B) see page 104</p> <p>... fronts in Design Slat (C): see page 105</p> <p>... fronts in Design Glass (D) – panel: see page 106</p> <p>... fronts in Design Glass (D) – veneer-covered aluminium frame: see page 106</p> <p>... drawers (instead of flaps): see page 106</p>	2 doors in Design Plain (A)				
	Width		Type no.		Price group I
			Door hinge left	Door hinge right	
	33.0 cm deep	35,2 cm	5502103	5502104	-
		52,8 cm – as illustrated	5503103	5503104	-
	45.0 cm deep	35,2 cm	5502203	5502204	-
		52,8 cm – as illustrated	5503203	5503204	-
	1 glass door in Design Glass (D) and 1 door in Design Plain (A)				
Width		Type no.		Price group I	
		Door hinge left	Door hinge right		
33.0 cm deep	35,2 cm	5502163	5502164	-	
	52,8 cm – as illustrated	5503163	5503164	-	
45.0 cm deep	35,2 cm	5502263	5502264	-	
	52,8 cm – as illustrated	5503263	5503264	-	
4 doors in Design Plain (A)					
Width		Type no.		Price group I	
33.0 cm deep	70,4 cm	5504104		-	
	105,6 cm – as illustrated	5506104		-	
45.0 cm deep	70,4 cm	5504204		-	
	105,6 cm – as illustrated	5506204		-	
2 glass doors in Design Glass (D) and 2 doors in Design Plain (A)					
Width		Type no.		Price group I	
33.0 cm deep	70,4 cm	5504165		-	
	105,6 cm – as illustrated	5506165		-	
45.0 cm deep	70,4 cm	5504265		-	
	105,6 cm – as illustrated	5506265		-	

Important note:
Cover shelves are essential and must be ordered separately (see pages 84-85)!

When used as wall units or stacked units:
Max. load per unit: 40 kg

Notes on delivery:
Please see here the information on range introduction pages.

Assembly notes for wall units:
Please be sure to note here the information and notes in the "Wall composition" chapter!

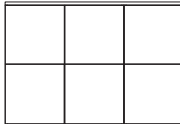
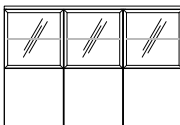
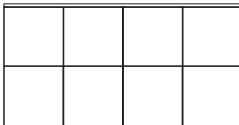
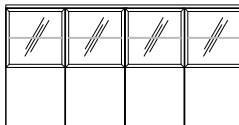

6 Raster units / highboards

<p>6 Raster units / highboards 105.6 cm high (107.4 cm high incl. 1.8 cm high plinth adjusters), 33.0 or 45.0 cm deep</p> <p>Surcharges for ...</p> <p>... carcasses in price group II: see pages 98-101</p> <p>... fronts in Design Plain (A) in price group II: see pages 102-103</p> <p>... fronts in Design Rear-lacquered glass (B) see page 104</p> <p>... fronts in Design Slat (C): see page 105</p> <p>... fronts in Design Glass (D) – panel: see page 106</p> <p>... fronts in Design Glass (D) – veneer-covered aluminium frame: see page 106</p> <p>... drawers (instead of flaps): see page 106</p> <p>Important note: Cover shelves are essential and must be ordered separately (see pages 84-85)!</p>	<p>6 doors in Design Plain (A)</p>  <p style="text-align: right;">3</p>			
		<p>Width (individual unit widths)</p>	<p>Type no.</p>	<p>Price group I</p>
	33.0 cm deep	158,4 cm (105,6 + 52,8 cm) – as illustrated	5509102	-
	45.0 cm deep	158,4 cm (105,6 + 52,8 cm) – as illustrated	5509202	-
	<p>3 glass doors in Design Glass (D) and 3 doors in Design Plain (A)</p>  <p style="text-align: right;">3</p>			
		<p>Width (individual unit widths)</p>	<p>Type no.</p>	<p>Price group I</p>
	33.0 cm deep	158,4 cm (105,6 + 52,8 cm) – as illustrated	5509163	-
	45.0 cm deep	158,4 cm (105,6 + 52,8 cm) – as illustrated	5509263	-
	<p>8 doors in Design Plain (A)</p>  <p style="text-align: right;">3</p>			
		<p>Width (individual unit widths)</p>	<p>Type no.</p>	<p>Price group I</p>
33.0 cm deep	211,2 cm (105,6 + 105,6 cm) – as illustrated	5512103	-	
45.0 cm deep	211,2 cm (105,6 + 105,6 cm) – as illustrated	5512203	-	
<p>4 glass doors in Design Glass (D) and 4 doors in Design Plain (A)</p>  <p style="text-align: right;">3</p>				
	<p>Width (individual unit widths)</p>	<p>Type no.</p>	<p>Price group I</p>	
33.0 cm deep	211,2 cm (105,6 + 105,6 cm) – as illustrated	5512164	-	
45.0 cm deep	211,2 cm (105,6 + 105,6 cm) – as illustrated	5512264	-	

When used as wall units or stacked units:
Max. load per unit: 40 kg

6 Raster units / highboards

Lamps: see page 97

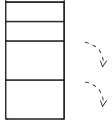
<p>6 Raster units / highboards 105.6 cm high (107.4 cm high incl. 1.8 cm high plinth adjusters), 33.0 or 45.0 cm deep</p> <p>Surcharges for ...</p> <p>... carcasses in price group II: see pages 98-101</p> <p>... fronts in Design Plain (A) in price group II: see pages 102-103</p> <p>... fronts in Design Rear-lacquered glass (B) see page 104</p> <p>... fronts in Design Slat (C): see page 105</p> <p>... fronts in Design Glass (D) – panel: see page 106</p> <p>... fronts in Design Glass (D) – veneer-covered aluminium frame: see page 106</p> <p>... drawers (instead of flaps): see page 106</p>	<p>2 drawers and 1 door in Design Plain (A)</p> 				
		Width	Type no.		Price group I
			Door hinge left	Door hinge right	
	33.0 cm deep	35,2 cm	5502105	5502106	-
		52,8 cm – as illustrated	5503105	5503106	-
		70,4 cm – 2 doors	5504105		-
		105,6 cm – 2 doors	5506105		-
	45.0 cm deep	35,2 cm	5502205	5502206	-
		52,8 cm – as illustrated	5503205	5503206	-
		70,4 cm – 2 doors	5504205		-
	105,6 cm – 2 doors	5506205		-	
<p>6 drawers in Design Plain (A)</p> 					
	Width	Type no.		Price group I	
33.0 cm deep	35,2 cm	5502107		-	
	52,8 cm – as illustrated	5503107		-	
	70,4 cm	5504107		-	
	105,6 cm	5506107		-	
45.0 cm deep	35,2 cm	5502207		-	
	52,8 cm – as illustrated	5503207		-	
	70,4 cm	5504207		-	
	105,6 cm	5506207		-	
<p>2 drawers and 2 flaps in Design Plain (A)</p> 					
	Width	Type no.		Price group I	
33.0 cm deep	35,2 cm	5502108		-	
	52,8 cm – as illustrated	5503108		-	
	70,4 cm	5504108		-	
	105,6 cm	5506108		-	
45.0 cm deep	35,2 cm	5502208		-	
	52,8 cm – as illustrated	5503208		-	
	70,4 cm	5504208		-	
	105,6 cm	5506208		-	

Important note:
Cover shelves are essential and must be ordered separately (see pages 84-85)!

When used as wall units or stacked units:
Max. load per unit: 40 kg

Notes on delivery:
Please see here the information on range introduction pages.

Assembly notes for wall units:
Please be sure to note here the information and notes in the "Wall composition" chapter!

6 Raster units / highboards

<p>6 Raster units / highboards 105.6 cm high (107.4 cm high incl. 1.8 cm high plinth adjusters), 33.0 or 45.0 cm deep</p> <p>Surcharges for ...</p> <p>... carcasses in price group II: see pages 98-101</p> <p>... fronts in Design Plain (A) in price group II: see pages 102-103</p> <p>... fronts in Design Rear-lacquered glass (B) see page 104</p> <p>... fronts in Design Slat (C): see page 105</p> <p>... fronts in Design Glass (D) – panel: see page 106</p> <p>... fronts in Design Glass (D) – veneer-covered aluminium frame: see page 106</p> <p>... drawers (instead of flaps): see page 106</p> <p>Important note: Cover shelves are essential and must be ordered separately (see pages 84-85)!</p>	2 flaps and 2 drawers in Design Plain (A)			
		Width	Type no.	Price group I
	33.0 cm deep	35,2 cm	5502109	-
		52,8 cm – as illustrated	5503109	-
		70,4 cm	5504109	-
		105,6 cm	5506109	-
	45.0 cm deep	35,2 cm	5502209	-
		52,8 cm – as illustrated	5503209	-
		70,4 cm	5504209	-
105,6 cm		5506209	-	
4 flaps and 4 drawers in Design Plain (A)				
	Width (individual unit widths)	Type no.	Price group I	
33.0 cm deep	105,6 cm (52,8 + 52,8 cm)	5506106	-	
	140,8 cm (70,4 + 70,4 cm) – as illustrated	5508106	-	
	211,2 cm (105,6 + 105,6 cm)	5512106	-	
45.0 cm deep	105,6 cm (52,8 + 52,8 cm)	5506206	-	
	140,8 cm (70,4 + 70,4 cm) – as illustrated	5508206	-	
	211,2 cm (105,6 + 105,6 cm)	5512206	-	
3 flaps in Design Plain (A)				
	Width	Type no.	Price group I	
33.0 cm deep	35,2 cm	5502110	-	
	52,8 cm – as illustrated	5503110	-	
	70,4 cm	5504110	-	
	105,6 cm	5506110	-	
45.0 cm deep	35,2 cm	5502210	-	
	52,8 cm – as illustrated	5503210	-	
	70,4 cm	5504210	-	
	105,6 cm	5506210	-	
6 flaps in Design Plain (A)				
	Width (individual unit widths)	Type no.	Price group I	
33.0 cm deep	105,6 cm (52,8 + 52,8 cm)	5506101	-	
	140,8 cm (70,4 + 70,4 cm) – as illustrated	5508105	-	
	211,2 cm (105,6 + 105,6 cm)	5512105	-	
45.0 cm deep	105,6 cm (52,8 + 52,8 cm)	5506201	-	
	140,8 cm (70,4 + 70,4 cm) – as illustrated	5508205	-	
	211,2 cm (105,6 + 105,6 cm)	5512205	-	
When used as wall units or stacked units: Max. load per unit: 40 kg				

6 Raster units / highboards

Lamps: see page 97

6 Raster units / highboards
 105.6 cm high
 (107.4 cm high incl. 1.8 cm high plinth adjusters),
33.0 or 45.0 cm deep

2 drawers and 2 flaps in Design Plain (A) as well as 2 glass doors in Design Glass (D)

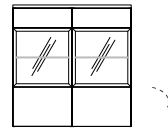

Width (individual unit widths)

Type no.

Price group I

Depth	Width (individual unit widths)	Type no.	Price group I
33.0 cm deep	105,6 cm (52,8 + 52,8 cm) – as illustrated	5506166	-
45.0 cm deep	105,6 cm (52,8 + 52,8 cm) – as illustrated	5506266	-

Surcharges for ...

... carcasses in price group II:
 see pages 98-101

... fronts in Design Plain (A)
 in price group II:
 see pages 102-103

... fronts in Design Rear-lacquered glass (B)
 see page 104

... fronts in Design Slat (C):
 see page 105

... fronts in Design Glass (D)
 – panel:
 see page 106

... fronts in Design Glass (D)
 – veneer-covered aluminium frame:
 see page 106

... drawers (instead of flaps):
 see page 106

3 drawers and 3 flaps in Design Plain (A) as well as 3 glass doors in Design Glass (D)

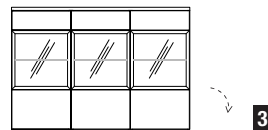

Width (individual unit widths)

Type no.

Price group I

Depth	Width (individual unit widths)	Type no.	Price group I
33.0 cm deep	158,4 cm (52,8 + 52,8 + 52,8 cm) – as illustrated	5509165	-
45.0 cm deep	158,4 cm (52,8 + 52,8 + 52,8 cm) – as illustrated	5509265	-

4 drawers and 4 flaps in Design Plain (A) as well as 4 glass doors in Design Glass (D)

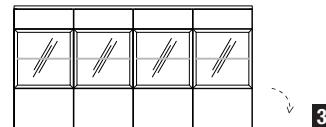

Width (individual unit widths)

Type no.

Price group I

Depth	Width (individual unit widths)	Type no.	Price group I
33.0 cm deep	211,2 cm (105,6 + 105,6 cm) – as illustrated	5512165	-
45.0 cm deep	211,2 cm (105,6 + 105,6 cm) – as illustrated	5512265	-

Important note:
 Cover shelves are essential
 and must be ordered separately
 (see pages 84-85)!

When used as wall units or stacked units:
 Max. load per unit: 40 kg

<p>6 Raster units / highboards 105.6 cm high (107.4 cm high incl. 1.8 cm high plinth adjusters), 33.0 or 45.0 cm deep</p> <p>Surcharges for ...</p> <p>... carcasses in price group II: see pages 98-101</p> <p>... fronts in Design Plain (A) in price group II: see pages 102-103</p> <p>... fronts in Design Rear-lacquered glass (B) see page 104</p> <p>... fronts in Design Slat (C): see page 105</p> <p>... fronts in Design Glass (D) – panel: see page 106</p> <p>... fronts in Design Glass (D) – veneer-covered aluminium frame: see page 106</p> <p>... drawers (instead of flaps): see page 106</p>	2 doors and 3 flaps in Design Plain (A)				
		Width (individual unit widths)	Type no.	Price group I	
	33.0 cm deep	140,8 cm (35,2 + 70,4 + 35,2 cm) – as illustrated	3	5508110	-
		158,4 cm (52,8 + 52,8 + 52,8 cm)	3	5509110	-
		176,0 cm (52,8 + 70,4 + 52,8 cm)	4	5510110	-
		211,2 cm (52,8 + 105,6 + 52,8 cm)	4	5512111	-
		211,2 cm (70,4 + 70,4 + 70,4 cm)	4	5512112	-
	45.0 cm deep	140,8 cm (35,2 + 70,4 + 35,2 cm) – as illustrated	3	5508210	-
		158,4 cm (52,8 + 52,8 + 52,8 cm)	3	5509210	-
176,0 cm (52,8 + 70,4 + 52,8 cm)		4	5510210	-	
211,2 cm (52,8 + 105,6 + 52,8 cm)		4	5512211	-	
211,2 cm (70,4 + 70,4 + 70,4 cm)		4	5512212	-	
2 glass doors in Design Glass (D) and 3 flaps in Design Plain (A)					
	Width (individual unit widths)	Type no.	Price group I		
33.0 cm deep	140,8 cm (35,2 + 70,4 + 35,2 cm) – as illustrated	3	5508170	-	
	158,4 cm (52,8 + 52,8 + 52,8 cm)	3	5509170	-	
	176,0 cm (52,8 + 70,4 + 52,8 cm)	4	5510170	-	
	211,2 cm (52,8 + 105,6 + 52,8 cm)	4	5512170	-	
	211,2 cm (70,4 + 70,4 + 70,4 cm)	4	5512171	-	
45.0 cm deep	140,8 cm (35,2 + 70,4 + 35,2 cm) – as illustrated	3	5508270	-	
	158,4 cm (52,8 + 52,8 + 52,8 cm)	3	5509270	-	
	176,0 cm (52,8 + 70,4 + 52,8 cm)	4	5510270	-	
	211,2 cm (52,8 + 105,6 + 52,8 cm)	4	5512270	-	
	211,2 cm (70,4 + 70,4 + 70,4 cm)	4	5512271	-	
3 doors and 2 drawers in Design Plain (A)					
	Width (individual unit widths)	Type no.	Price group I		
33.0 cm deep	158,4 cm (52,8 + 52,8 + 52,8 cm) – as illustrated	3	5509111	-	
	211,2 cm (70,4 + 70,4 + 70,4 cm)	4	5512113	-	
45.0 cm deep	158,4 cm (52,8 + 52,8 + 52,8 cm) – as illustrated	3	5509211	-	
	211,2 cm (70,4 + 70,4 + 70,4 cm)	4	5512213	-	
2 glass doors in Design Glass (D) as well as 1 door and 2 drawers in Design Plain (A)					
	Width (individual unit widths)	Type no.	Price group I		
33.0 cm deep	158,4 cm (52,8 + 52,8 + 52,8 cm) – as illustrated	3	5509171	-	
	211,2 cm (70,4 + 70,4 + 70,4 cm)	4	5512173	-	
45.0 cm deep	158,4 cm (52,8 + 52,8 + 52,8 cm) – as illustrated	3	5509271	-	
	211,2 cm (70,4 + 70,4 + 70,4 cm)	4	5512273	-	

Important note:
Cover shelves are essential and must be ordered separately (see pages 84-85)!

When used as wall units or stacked units:
Max. load per unit: 40 kg

Notes on delivery:
Please see here the information on range introduction pages.

T

Assembly notes for wall units:
Please be sure to note here the information and notes in the "Wall composition" chapter!

3

4

6 Raster units / highboards

SPECTRUM

6 Raster units / highboards
105.6 cm high
(107.4 cm high incl. 1.8 cm high plinth adjusters),
33.0 or 45.0 cm deep

4 doors and 2 drawers in Design Plain (A)

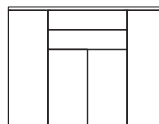

Width (individual unit widths)

Type no.

Price group I

Depth	Width (individual unit widths)	Type no.	Price group I
33.0 cm deep	140,8 cm (35,2 + 70,4 + 35,2 cm) – as illustrated	3 5508114	-
	211,2 cm (52,8 + 105,6 + 52,8 cm)	4 5512114	-
45.0 cm deep	140,8 cm (35,2 + 70,4 + 35,2 cm) – as illustrated	3 5508214	-
	211,2 cm (52,8 + 105,6 + 52,8 cm)	4 5512214	-

Surcharges for ...

... carcasses in price group II:
see pages 98-101

... fronts in Design Plain (A) in price group II:
see pages 102-103

... fronts in Design Rear-lacquered glass (B)
see page 104

... fronts in Design Slat (C):
see page 105

... fronts in Design Glass (D) – panel:
see page 106

... fronts in Design Glass (D) – veneer-covered aluminium frame:
see page 106

... drawers (instead of flaps):
see page 106

2 glass doors in Design Glass (D) as well as 2 doors and 2 drawers in Design Plain (A)



Width (individual unit widths)

Type no.

Price group I

Depth	Width (individual unit widths)	Type no.	Price group I
33.0 cm deep	140,8 cm (35,2 + 70,4 + 35,2 cm) – as illustrated	3 5508174	-
	211,2 cm (52,8 + 105,6 + 52,8 cm)	4 5512174	-
45.0 cm deep	140,8 cm (35,2 + 70,4 + 35,2 cm) – as illustrated	3 5508274	-
	211,2 cm (52,8 + 105,6 + 52,8 cm)	4 5512274	-

Important note:
Cover shelves are essential and must be ordered separately (see pages 84-85)!

When used as wall units or stacked units:
Max. load per unit: 40 kg

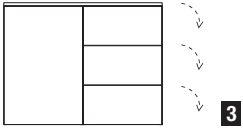
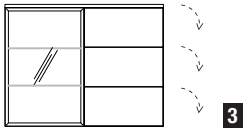
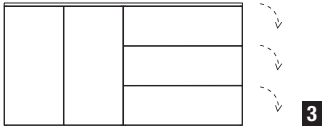
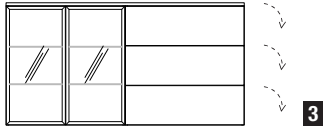
<p>6 Raster units / highboards 105.6 cm high (107.4 cm high incl. 1.8 cm high plinth adjusters), 33.0 or 45.0 cm deep</p> <p>Surcharges for ...</p> <p>... carcasses in price group II: see pages 98-101</p> <p>... fronts in Design Plain (A) in price group II: see pages 102-103</p> <p>... fronts in Design Rear-lacquered glass (B) see page 104</p> <p>... fronts in Design Slat (C): see page 105</p> <p>... fronts in Design Glass (D) – panel: see page 106</p> <p>... fronts in Design Glass (D) – veneer-covered aluminium frame: see page 106</p> <p>... drawers (instead of flaps): see page 106</p>	<p>1 door and 3 flaps in Design Plain (A)</p> 			
		<p>Width (individual unit widths)</p>	<p>Type no.</p>	<p>Price group I</p>
	33.0 cm deep	<p>140,8 cm (70,4 + 70,4 cm) – as illustrated 158,4 cm (52,8 + 105,6 cm)</p>	<p>5508115 5509115</p>	<p>- -</p>
	45.0 cm deep	<p>140,8 cm (70,4 + 70,4 cm) – as illustrated 158,4 cm (52,8 + 105,6 cm)</p>	<p>5508215 5509215</p>	<p>- -</p>
	<p>1 glass door in Design Glass (D) and 3 flaps in Design Plain (A)</p> 			
		<p>Width (individual unit widths)</p>	<p>Type no.</p>	<p>Price group I</p>
	33.0 cm deep	<p>140,8 cm (70,4 + 70,4 cm) – as illustrated 158,4 cm (52,8 + 105,6 cm)</p>	<p>5508175 5509175</p>	<p>- -</p>
	45.0 cm deep	<p>140,8 cm (70,4 + 70,4 cm) – as illustrated 158,4 cm (52,8 + 105,6 cm)</p>	<p>5508275 5509275</p>	<p>- -</p>
	<p>2 doors and 3 flaps in Design Plain (A)</p> 			
		<p>Width (individual unit widths)</p>	<p>Type no.</p>	<p>Price group I</p>
33.0 cm deep	<p>211,2 cm (105,6 + 105,6 cm) – as illustrated</p>	<p>5512116</p>	<p>-</p>	
45.0 cm deep	<p>211,2 cm (105,6 + 105,6 cm) – as illustrated</p>	<p>5512216</p>	<p>-</p>	
<p>2 glass doors in Design Glass (D) and 3 flaps in Design Plain (A)</p> 				
	<p>Width (individual unit widths)</p>	<p>Type no.</p>	<p>Price group I</p>	
33.0 cm deep	<p>211,2 cm (105,6 + 105,6 cm) – as illustrated</p>	<p>5512176</p>	<p>-</p>	
45.0 cm deep	<p>211,2 cm (105,6 + 105,6 cm) – as illustrated</p>	<p>5512276</p>	<p>-</p>	

Important note:
Cover shelves are essential and must be ordered separately (see pages 84-85)!

Mirror-image types are possible. Please add an „S“ to the type no. in this case.

When used as wall units or stacked units:
Max. load per unit: 40 kg

Notes on delivery:
Please see here the information on range introduction pages.

T

Assembly notes for wall units:
Please be sure to note here the information and notes in the "Wall composition" chapter!

3

4

7 Raster units / highboards

SPECTRUM

<p>7 Raster units / highboards 123.2 cm high (125.0 cm high incl. 1.8 cm high plinth adjusters), 33.0 or 45.0 cm deep</p> <p>Surcharges for ...</p> <p>... carcasses in price group II: see pages 98-101</p> <p>... fronts in Design Plain (A) in price group II: see pages 102-103</p> <p>... fronts in Design Rear-lacquered glass (B) see page 104</p> <p>... fronts in Design Slat (C): see page 105</p> <p>... fronts in Design Glass (D) – panel: see page 106</p> <p>... fronts in Design Glass (D) – veneer-covered aluminium frame: see page 106</p> <p>... drawers (instead of flaps): see page 106</p> <p>Important note: Cover shelves are essential and must be ordered separately (see pages 84-85)!</p>	1 door in Design Plain (A)				
		Width	Type no.		Price group I
			Door hinge left	Door hinge right	
	33.0 cm deep	35,2 cm	5602101	5602102	-
		52,8 cm – as illustrated	5603101	5603102	-
	45.0 cm deep	35,2 cm	5602201	5602202	-
		52,8 cm – as illustrated	5603201	5603202	-
	2 doors in Design Plain (A)				
	Width	Type no.		Price group I	
33.0 cm deep	70,4 cm	5604117		-	
	105,6 cm – as illustrated	5606117		-	
45.0 cm deep	70,4 cm	5604217		-	
	105,6 cm – as illustrated	5606217		-	
3 doors in Design Plain (A)					
	Width (individual unit widths)	Type no.		Price group I	
33.0 cm deep	158,4 cm (105,6 + 52,8 cm) – as illustrated	5609101		-	
45.0 cm deep	158,4 cm (105,6 + 52,8 cm) – as illustrated	5609201		-	
1 glass door in Design Glass (D) and 1 door in Design Plain (A)					
	Width	Type no.		Price group I	
		Door hinge left	Door hinge right		
33.0 cm deep	35,2 cm	5602175	5602176	-	
	52,8 cm – as illustrated	5603175	5603176	-	
45.0 cm deep	35,2 cm	5602275	5602276	-	
	52,8 cm – as illustrated	5603275	5603276	-	
When used as wall units or stacked units: Max. load per unit: 40 kg					

7 Raster units / highboards

Lamps: see page 97

7 Raster units / highboards
123.2 cm high
(125.0 cm high incl. 1.8 cm high plinth adjusters),
33.0 or 45.0 cm deep

Surcharges for ...

... carcasses in price group II:
see pages 98-101

... fronts in Design Plain (A)
in price group II:
see pages 102-103

... fronts in Design Rear-lacquered glass (B)
see page 104

... fronts in Design Slat (C):
see page 105

... fronts in Design Glass (D)
– panel:
see page 106

... fronts in Design Glass (D)
– veneer-covered aluminium frame:
see page 106

... drawers (instead of flaps):
see page 106

Important note:
Cover shelves are essential and must be ordered separately (see pages 84-85)!

2 doors in Design Plain (A)



	Width	Type no.		Price group I
		Door hinge left	Door hinge right	
33.0 cm deep	35,2 cm	5602103	5602104	-
	52,8 cm – as illustrated	5603103	5603104	-
45.0 cm deep	35,2 cm	5602203	5602204	-
	52,8 cm – as illustrated	5603203	5603204	-

1 glass door in Design Glass (D) and 1 door in Design Plain (A)



	Width	Type no.		Price group I
		Door hinge left	Door hinge right	
33.0 cm deep	35,2 cm	5602163	5602164	-
	52,8 cm – as illustrated	5603163	5603164	-
45.0 cm deep	35,2 cm	5602263	5602264	-
	52,8 cm – as illustrated	5603263	5603264	-

4 doors in Design Plain (A)

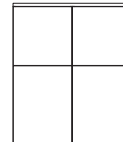

	Width	Type no.		Price group I
33.0 cm deep	70,4 cm	5604118	-	-
	105,6 cm – as illustrated	5606118	-	-
45.0 cm deep	70,4 cm	5604218	-	-
	105,6 cm – as illustrated	5606218	-	-

2 glass doors in Design Glass (D) and 2 doors in Design Plain (A)

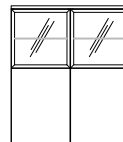

	Width	Type no.		Price group I
33.0 cm deep	70,4 cm	5604178	-	-
	105,6 cm – as illustrated	5606178	-	-
45.0 cm deep	70,4 cm	5604278	-	-
	105,6 cm – as illustrated	5606278	-	-



When used as wall units or stacked units:
Max. load per unit: 40 kg

Notes on delivery:
Please see here the information on range introduction pages.

Assembly notes for wall units:
Please be sure to note here the information and notes in the "Wall composition" chapter!

7 Raster units / highboards

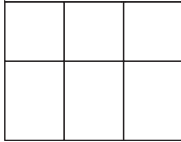
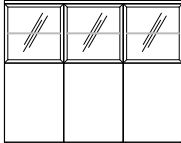
SPECTRUM

<p>7 Raster units / highboards 123.2 cm high (125.0 cm high incl. 1.8 cm high plinth adjusters), 33.0 or 45.0 cm deep</p> <p>Surcharges for ...</p> <p>... carcasses in price group II: see pages 98-101</p> <p>... fronts in Design Plain (A) in price group II: see pages 102-103</p> <p>... fronts in Design Rear-lacquered glass (B) see page 104</p> <p>... fronts in Design Slat (C): see page 105</p> <p>... fronts in Design Glass (D) – panel: see page 106</p> <p>... fronts in Design Glass (D) – veneer-covered aluminium frame: see page 106</p> <p>... drawers (instead of flaps): see page 106</p>	<p>6 doors in Design Plain (A)</p>  <p style="text-align: right;">4 T</p>				
	Width (individual unit widths)		Type no.		Price group I
	33.0 cm deep	158,4 cm (105,6 + 52,8 cm) – as illustrated	5609102		-
	45.0 cm deep	158,4 cm (105,6 + 52,8 cm) – as illustrated	5609202		-
	<p>3 glass doors in Design Glass (D) and 3 doors in Design Plain (A)</p>  <p style="text-align: right;">4 T</p>				
	Width (individual unit widths)		Type no.		Price group I
	33.0 cm deep	158,4 cm (105,6 + 52,8 cm) – as illustrated	5609162		-
	45.0 cm deep	158,4 cm (105,6 + 52,8 cm) – as illustrated	5609262		-
	<p>1 door and 1 flap in Design Plain (A)</p> 				
	Width		Type no.		Price group I
33.0 cm deep	35,2 cm	Door hinge left	Door hinge right	-	
	52,8 cm – as illustrated	5602105	5602106	-	
	70,4 cm – 2 doors	5603105	5603106	-	
	105,6 cm – 2 doors	5604105		-	
45.0 cm deep	35,2 cm	5602205	5602206	-	
	52,8 cm – as illustrated	5603205	5603206	-	
	70,4 cm – 2 doors	5604205		-	
	105,6 cm – 2 doors	5606205		-	
<p>1 door and 2 drawers in Design Plain (A)</p> 					
Width		Type no.		Price group I	
33.0 cm deep	35,2 cm	Door hinge left	Door hinge right	-	
	52,8 cm – as illustrated	5602115	5602116	-	
	70,4 cm – 2 doors	5603115	5603116	-	
	105,6 cm – 2 doors	5604115		-	
45.0 cm deep	35,2 cm	5602215	5602216	-	
	52,8 cm – as illustrated	5603215	5603216	-	
	70,4 cm – 2 doors	5604215		-	
	105,6 cm – 2 doors	5606215		-	

When used as wall units or stacked units:
Max. load per unit: 40 kg

7 Raster units / highboards

Lamps: see page 97

7 Raster units / highboards
123.2 cm high
(125.0 cm high incl. 1.8 cm high plinth adjusters),
33.0 or 45.0 cm deep

Surcharges for ...

... carcasses in price group II: see pages 98-101

... fronts in Design Plain (A) in price group II: see pages 102-103

... fronts in Design Rear-lacquered glass (B) see page 104

... fronts in Design Slat (C): see page 105

... fronts in Design Glass (D) – panel: see page 106

... fronts in Design Glass (D) – veneer-covered aluminium frame: see page 106

... drawers (instead of flaps): see page 106

Important note:
Cover shelves are essential and must be ordered separately (see pages 84-85)!

1 flap and 1 door in Design Plain (A)

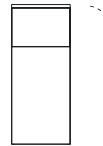

	Width	Type no.		Price group I
		Door hinge left	Door hinge right	
33.0 cm deep	35,2 cm	5602107	5602108	-
	52,8 cm – as illustrated	5603107	5603108	-
	70,4 cm – 2 doors	5604107		-
	105,6 cm – 2 doors	5606107		-
45.0 cm deep	35,2 cm	5602207	5602208	-
	52,8 cm – as illustrated	5603207	5603208	-
	70,4 cm – 2 doors	5604207		-
	105,6 cm – 2 doors	5606207		-

2 flaps and 2 doors in Design Plain (A)

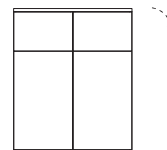

	Width	Type no.		Price group I
33.0 cm deep	105,6 cm – as illustrated	5606101		-
45.0 cm deep	105,6 cm – as illustrated	5606201		-

3 flaps and 3 doors in Design Plain (A)



	Width (individual unit widths)	Type no.		Price group I
33.0 cm deep	158,4 cm (105,6 + 52,8 cm) – as illustrated	5609103		-
45.0 cm deep	158,4 cm (105,6 + 52,8 cm) – as illustrated	5609203		-

When used as wall units or stacked units:
Max. load per unit: 40 kg

Notes on delivery:
Please see here the information on range introduction pages.

Assembly notes for wall units:
Please be sure to note here the information and notes in the "Wall composition" chapter!

7 Raster units / highboards

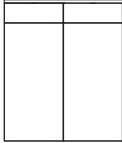
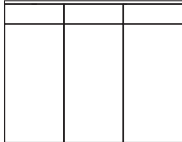
<p>7 Raster units / highboards 123.2 cm high (125.0 cm high incl. 1.8 cm high plinth adjusters), 33.0 or 45.0 cm deep</p> <p>Surcharges for ...</p> <p>... carcasses in price group II: see pages 98-101</p> <p>... fronts in Design Plain (A) in price group II: see pages 102-103</p> <p>... fronts in Design Rear-lacquered glass (B) see page 104</p> <p>... fronts in Design Slat (C): see page 105</p> <p>... fronts in Design Glass (D) – panel: see page 106</p> <p>... fronts in Design Glass (D) – veneer-covered aluminium frame: see page 106</p> <p>... drawers (instead of flaps): see page 106</p> <p>Important note: Cover shelves are essential and must be ordered separately (see pages 84-85)!</p>	<p>1 drawer and 1 door in Design Plain (A)</p> 				
		Width	Type no.		Price group I
			Door hinge left	Door hinge right	
	33.0 cm deep	35,2 cm 52,8 cm – as illustrated 70,4 cm – 2 doors 105,6 cm – 2 doors	5602111 5603111	5602112 5603112	- - - -
			5604111 5606111		- -
	45.0 cm deep	35,2 cm 52,8 cm – as illustrated 70,4 cm – 2 doors 105,6 cm – 2 doors	5602211 5603211	5602212 5603212	- - - -
			5604211 5606211		- -
	<p>2 drawers and 2 doors in Design Plain (A)</p> 				
		Width (individual unit widths)	Type no.		Price group I
	33.0 cm deep	105,6 cm (52,8 + 52,8 cm) – as illustrated	5606102		-
45.0 cm deep	105,6 cm (52,8 + 52,8 cm) – as illustrated	5606202		-	
<p>3 drawers and 3 doors in Design Plain (A)</p> 					
	Width (individual unit widths)	Type no.		Price group I	
33.0 cm deep	158,4 cm (52,8 + 52,8 + 52,8 cm) – as illustrated	5609104		-	
45.0 cm deep	158,4 cm (52,8 + 52,8 + 52,8 cm) – as illustrated	5609204		-	

When used as wall units or stacked units:
Max. load per unit: 40 kg

7 Raster units / highboards

Lamps: see page 97

<p>7 Raster units / highboards 123.2 cm high (125.0 cm high incl. 1.8 cm high plinth adjusters), 33.0 or 45.0 cm deep</p> <p>Surcharges for ...</p> <p>... carcasses in price group II: see pages 98-101</p> <p>... fronts in Design Plain (A) in price group II: see pages 102-103</p> <p>... fronts in Design Rear-lacquered glass (B) see page 104</p> <p>... fronts in Design Slat (C): see page 105</p> <p>... fronts in Design Glass (D) – panel: see page 106</p> <p>... fronts in Design Glass (D) – veneer-covered aluminium frame: see page 106</p> <p>... drawers (instead of flaps): see page 106</p> <p>Important note: Cover shelves are essential and must be ordered separately (see pages 84-85)!</p>	1 door and 1 drawer in Design Plain (A)				
		Width	Type no.		Price group I
			Door hinge left	Door hinge right	
	33.0 cm deep	35,2 cm	5602109	5602110	-
		52,8 cm – as illustrated	5603109	5603110	-
		70,4 cm – 2 doors 105,6 cm – 2 doors	5604109 5606109		-
	45.0 cm deep	35,2 cm	5602209	5602210	-
		52,8 cm – as illustrated	5603209	5603210	-
		70,4 cm – 2 doors 105,6 cm – 2 doors	5604209 5606209		-
1 glass door in Design Glass (D) and 1 drawer in Design Plain (A)					
	Width	Type no.		Price group I	
		Door hinge left	Door hinge right		
33.0 cm deep	35,2 cm	5602169	5602170	-	
	52,8 cm – as illustrated	5603169	5603170	-	
45.0 cm deep	35,2 cm	5602269	5602270	-	
	52,8 cm – as illustrated	5603269	5603270	-	
2 glass doors in Design Glass (D) and 2 drawers in Design Plain (A)					
	Width	Type no.		Price group I	
33.0 cm deep	70,4 cm	5604169		-	
	105,6 cm – as illustrated	5606169		-	
45.0 cm deep	70,4 cm	5604269		-	
	105,6 cm – as illustrated	5606269		-	

When used as wall units or stacked units:
Max. load per unit: 40 kg

Notes on delivery:
Please see here the information on range introduction pages.

Assembly notes for wall units:
Please be sure to note here the information and notes in the "Wall composition" chapter!

7 Raster units / highboards

7 Raster units / highboards
123.2 cm high
(125.0 cm high incl. 1.8 cm high plinth adjusters),
33.0 or 45.0 cm deep

Surcharges for ...

... carcasses in price group II:
see pages 98-101

... fronts in Design Plain (A) in price group II:
see pages 102-103

... fronts in Design Rear-lacquered glass (B)
see page 104

... fronts in Design Slat (C):
see page 105

... fronts in Design Glass (D) – panel:
see page 106

... fronts in Design Glass (D) – veneer-covered aluminium frame:
see page 106

... drawers (instead of flaps):
see page 106

Important note:
Cover shelves are essential and must be ordered separately (see pages 84-85)!

When used as wall units or stacked units:
Max. load per unit: 40 kg

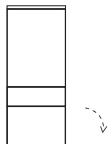
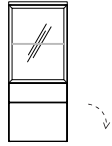
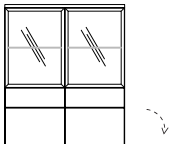
1 door, 1 drawer and 1 flap in Design Plain (A)				
				
Width	Type no.	Price group I		
		Door hinge left	Door hinge right	
33.0 cm deep	35,2 cm	5602113	5602114	-
	52,8 cm – as illustrated	5603113	5603114	-
	70,4 cm – 2 doors	5604113		-
	105,6 cm – 2 doors	5606113		-
45.0 cm deep	35,2 cm	5602213	5602214	-
	52,8 cm – as illustrated	5603213	5603214	-
	70,4 cm – 2 doors	5604213		-
	105,6 cm – 2 doors	5606213		-
1 glass door in Design Glass (D) as well as 1 drawer and 1 flap in Design Plain (A)				
				
Width	Type no.	Price group I		
		Door hinge left	Door hinge right	
33.0 cm deep	35,2 cm	5602173	5602174	-
	52,8 cm – as illustrated	5603173	5603174	-
	70,4 cm			
	105,6 cm			
45.0 cm deep	35,2 cm	5602273	5602274	-
	52,8 cm – as illustrated	5603273	5603274	-
	70,4 cm			
	105,6 cm			
2 glass doors in Design Glass (D) as well as 2 drawers and 2 flaps in Design Plain (A)				
				
Width	Type no.	Price group I		
33.0 cm deep	70,4 cm	5604173		-
	105,6 cm – as illustrated	5606173		-
	70,4 cm			
	105,6 cm			
45.0 cm deep	70,4 cm	5604273		-
	105,6 cm – as illustrated	5606273		-
	70,4 cm			
	105,6 cm			

7 Raster units / highboards

Lamps: see page 97

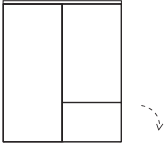
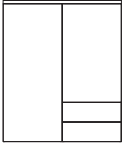
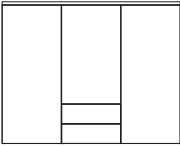
<p>7 Raster units / highboards 123.2 cm high (125.0 cm high incl. 1.8 cm high plinth adjusters), 33.0 or 45.0 cm deep</p> <p>Surcharges for ...</p> <p>... carcasses in price group II: see pages 98-101</p> <p>... fronts in Design Plain (A) in price group II: see pages 102-103</p> <p>... fronts in Design Rear-lacquered glass (B) see page 104</p> <p>... fronts in Design Slat (C): see page 105</p> <p>... fronts in Design Glass (D) – panel: see page 106</p> <p>... fronts in Design Glass (D) – veneer-covered aluminium frame: see page 106</p> <p>... drawers (instead of flaps): see page 106</p> <p>Important note: Cover shelves are essential and must be ordered separately (see pages 84-85)!</p> <p>Mirror-image types are possible. Please add an „S“ to the type no. in this case.</p>	<p>2 doors and 1 flap in Design Plain (A)</p> 			
		<p>Width (individual unit widths)</p>	<p>Type no.</p>	<p>Price group I</p>
	33.0 cm deep	105,6 cm (52,8 + 52,8 cm) – as illustrated	5606103	-
	45.0 cm deep	105,6 cm (52,8 + 52,8 cm) – as illustrated	5606203	-
	<p>2 doors and 2 drawers in Design Plain (A)</p> 			
		<p>Width (individual unit widths)</p>	<p>Type no.</p>	<p>Price group I</p>
	33.0 cm deep	105,6 cm (52,8 + 52,8 cm) – as illustrated	5606119	-
	45.0 cm deep	105,6 cm (52,8 + 52,8 cm) – as illustrated	5606219	-
	<p>3 doors and 2 drawers in Design Plain (A)</p> 			
		<p>Width (individual unit widths)</p>	<p>Type no.</p>	<p>Price group I</p>
33.0 cm deep	158,4 cm (52,8 + 52,8 + 52,8 cm) – as illustrated	5609106	-	
45.0 cm deep	158,4 cm (52,8 + 52,8 + 52,8 cm) – as illustrated	5609206	-	

4 T

Notes on delivery:
Please see here the information on range introduction pages.

T

Assembly notes for wall units:
Please be sure to note here the information and notes in the "Wall composition" chapter!

3

4

7 Raster units / highboards

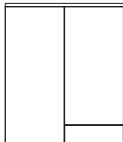
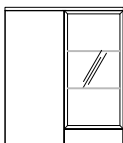
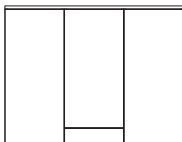
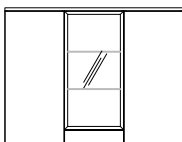

SPECTRUM

<p>7 Raster units / highboards 123.2 cm high (125.0 cm high incl. 1.8 cm high plinth adjusters), 33.0 or 45.0 cm deep</p> <p>Surcharges for ...</p> <p>... carcasses in price group II: see pages 98-101</p> <p>... fronts in Design Plain (A) in price group II: see pages 102-103</p> <p>... fronts in Design Rear-lacquered glass (B) see page 104</p> <p>... fronts in Design Slat (C): see page 105</p> <p>... fronts in Design Glass (D) – panel: see page 106</p> <p>... fronts in Design Glass (D) – veneer-covered aluminium frame: see page 106</p> <p>... drawers (instead of flaps): see page 106</p> <p>Important note: Cover shelves are essential and must be ordered separately (see pages 84-85)!</p> <p>Mirror-image types are possible. Please add an „S“ to the type no. in this case.</p>	<p>2 doors and 1 drawer in Design Plain (A)</p> 			
		<p>Width (individual unit widths)</p>	<p>Type no.</p>	<p>Price group I</p>
	33.0 cm deep	105,6 cm (52,8 + 52,8 cm) – as illustrated	5606104	-
	45.0 cm deep	105,6 cm (52,8 + 52,8 cm) – as illustrated	5606204	-
	<p>1 door and 1 drawer in Design Plain (A) as well as 1 glass door in Design Glass (D)</p> 			
		<p>Width (individual unit widths)</p>	<p>Type no.</p>	<p>Price group I</p>
	33.0 cm deep	105,6 cm (52,8 + 52,8 cm) – as illustrated	5606164	-
	45.0 cm deep	105,6 cm (52,8 + 52,8 cm) – as illustrated	5606264	-
	<p>3 doors and 1 drawer in Design Plain (A)</p> 			
		<p>Width (individual unit widths)</p>	<p>Type no.</p>	<p>Price group I</p>
33.0 cm deep	158,4 cm (52,8 + 52,8 + 52,8 cm) – as illustrated	5609105	-	
45.0 cm deep	158,4 cm (52,8 + 52,8 + 52,8 cm) – as illustrated	5609205	-	
<p>2 doors and 1 drawer in Design Plain (A) as well as 1 glass door in Design Glass (D)</p> 				
	<p>Width (individual unit widths)</p>	<p>Type no.</p>	<p>Price group I</p>	
33.0 cm deep	158,4 cm (52,8 + 52,8 + 52,8 cm) – as illustrated	5609165	-	
45.0 cm deep	158,4 cm (52,8 + 52,8 + 52,8 cm) – as illustrated	5609265	-	

When used as wall units or stacked units:
Max. load per unit: 40 kg

7 Raster units / highboards

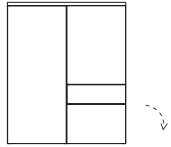
Lamps: see page 97

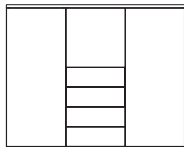
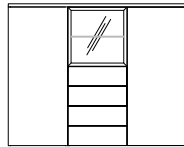
<p>7 Raster units / highboards 123.2 cm high (125.0 cm high incl. 1.8 cm high plinth adjusters), 33.0 or 45.0 cm deep</p> <p>Surcharges for ...</p> <p>... carcasses in price group II: see pages 98-101</p> <p>... fronts in Design Plain (A) in price group II: see pages 102-103</p> <p>... fronts in Design Rear-lacquered glass (B) see page 104</p> <p>... fronts in Design Slat (C): see page 105</p> <p>... fronts in Design Glass (D) – panel: see page 106</p> <p>... fronts in Design Glass (D) – veneer-covered aluminium frame: see page 106</p> <p>... drawers (instead of flaps): see page 106</p> <p>Important note: Cover shelves are essential and must be ordered separately (see pages 84-85)!</p> <p>Mirror-image types are possible. Please add an „S“ to the type no. in this case.</p>	<p>2 doors, 1 drawer and 1 flap in Design Plain (A)</p> 			
		<p>Width (individual unit widths)</p>	<p>Type no.</p>	<p>Price group I</p>
	33.0 cm deep	105,6 cm (52,8 + 52,8 cm) – as illustrated	5606106	-
	45.0 cm deep	105,6 cm (52,8 + 52,8 cm) – as illustrated	5606206	-
	<p>1 door, 1 drawer and 1 flap in Design Plain (A) as well as 1 glass door in Design Glass (D)</p> 			
		<p>Width (individual unit widths)</p>	<p>Type no.</p>	<p>Price group I</p>
	33.0 cm deep	105,6 cm (52,8 + 52,8 cm) – as illustrated	5606166	-
	45.0 cm deep	105,6 cm (52,8 + 52,8 cm) – as illustrated	5606266	-
	<p>3 doors and 4 drawers in Design Plain (A)</p> 			
		<p>Width (individual unit widths)</p>	<p>Type no.</p>	<p>Price group I</p>
33.0 cm deep	158,4 cm (52,8 + 52,8 + 52,8 cm) – as illustrated	5609107	-	
45.0 cm deep	158,4 cm (52,8 + 52,8 + 52,8 cm) – as illustrated	5609207	-	
<p>2 doors and 4 drawers in Design Plain (A) as well as 1 glass door in Design Glass (D)</p> 				
	<p>Width (individual unit widths)</p>	<p>Type no.</p>	<p>Price group I</p>	
33.0 cm deep	158,4 cm (52,8 + 52,8 + 52,8 cm) – as illustrated	5609167	-	
45.0 cm deep	158,4 cm (52,8 + 52,8 + 52,8 cm) – as illustrated	5609267	-	

Notes on delivery:
Please see here the information on range introduction pages.

T

Assembly notes for wall units:
Please be sure to note here the information and notes in the "Wall composition" chapter!

3

4

7 Raster units / highboards

SPECTRUM

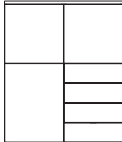
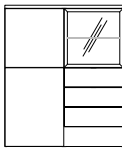
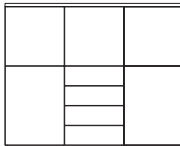
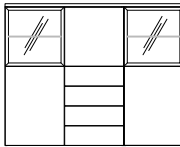
<p>7 Raster units / highboards 123.2 cm high (125.0 cm high incl. 1.8 cm high plinth adjusters), 33.0 or 45.0 cm deep</p> <p>Surcharges for ...</p> <p>... carcasses in price group II: see pages 98-101</p> <p>... fronts in Design Plain (A) in price group II: see pages 102-103</p> <p>... fronts in Design Rear-lacquered glass (B) see page 104</p> <p>... fronts in Design Slat (C): see page 105</p> <p>... fronts in Design Glass (D) – panel: see page 106</p> <p>... fronts in Design Glass (D) – veneer-covered aluminium frame: see page 106</p> <p>... drawers (instead of flaps): see page 106</p> <p>Important note: Cover shelves are essential and must be ordered separately (see pages 84-85)!</p> <p>Mirror-image types are possible. Please add an „S“ to the type no. in this case.</p>	<p>3 doors and 4 drawers in Design Plain (A)</p> 			
		<p>Width (individual unit widths)</p>	<p>Type no.</p>	<p>Price group I</p>
	33.0 cm deep	105,6 cm (52,8 + 52,8 cm) – as illustrated	5606110	-
	45.0 cm deep	105,6 cm (52,8 + 52,8 cm) – as illustrated	5606210	-
	<p>2 doors and 4 drawers in Design Plain (A) as well as 1 glass door in Design Glass (D)</p> 			
		<p>Width (individual unit widths)</p>	<p>Type no.</p>	<p>Price group I</p>
	33.0 cm deep	105,6 cm (52,8 + 52,8 cm) – as illustrated	5606170	-
	45.0 cm deep	105,6 cm (52,8 + 52,8 cm) – as illustrated	5606270	-
	<p>5 doors and 4 drawers in Design Plain (A)</p> 			
		<p>Width (individual unit widths)</p>	<p>Type no.</p>	<p>Price group I</p>
33.0 cm deep	158,4 cm (52,8 + 52,8 + 52,8 cm) – as illustrated	5609108	-	
45.0 cm deep	158,4 cm (52,8 + 52,8 + 52,8 cm) – as illustrated	5609208	-	
<p>2 glass doors in Design Glass (D) as well as 3 doors and 4 drawers in Design Plain (A)</p> 				
	<p>Width (individual unit widths)</p>	<p>Type no.</p>	<p>Price group I</p>	
33.0 cm deep	158,4 cm (52,8 + 52,8 + 52,8 cm) – as illustrated	5609168	-	
45.0 cm deep	158,4 cm (52,8 + 52,8 + 52,8 cm) – as illustrated	5609268	-	

When used as wall units or stacked units:
Max. load per unit: 40 kg

8 Raster units / highboards

Lamps: see page 97

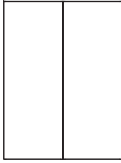
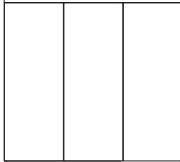
<p>8 Raster units / highboards 140.8 cm high (142.6 cm high incl. 1.8 cm high plinth adjusters), 33.0 or 45.0 cm deep</p> <p>Surcharges for ...</p> <p>... carcasses in price group II: see pages 98-101</p> <p>... fronts in Design Plain (A) in price group II: see pages 102-103</p> <p>... fronts in Design Rear-lacquered glass (B) see page 104</p> <p>... fronts in Design Slat (C): see page 105</p> <p>... fronts in Design Glass (D) – panel: see page 106</p> <p>... fronts in Design Glass (D) – veneer-covered aluminium frame: see page 106</p> <p>... drawers (instead of flaps): see page 106</p>	<p>1 door in Design Plain (A)</p> 				
		Width	Type no.		Price group I
			Door hinge left	Door hinge right	
	33.0 cm deep	35,2 cm 52,8 cm – as illustrated 70,4 cm	5702101 5703101 5704101	5702102 5703102 5704102	- - -
	45.0 cm deep	35,2 cm 52,8 cm – as illustrated 70,4 cm	5702201 5703201 5704201	5702202 5703202 5704202	- - -
	<p>2 doors in Design Plain (A)</p>  <p style="text-align: center;">This unit in 105.6 cm width cannot be fitted as a wall unit!</p>				
		Width (individual unit widths)	Type no.		Price group I
	33.0 cm deep	70,4 cm 105,6 cm – as illustrated 140,8 cm (70,4 + 70,4 cm) T 4	5704113 5706113 5708101		- - -
	45.0 cm deep	70,4 cm 105,6 cm – as illustrated 140,8 cm (70,4 + 70,4 cm) T 4	5704213 5706213 5708201		- - -
	<p>3 doors in Design Plain (A)</p>  <p style="text-align: center;">This unit in 158.4 cm width cannot be fitted as a wall unit!</p>				
	Width (individual unit widths)	Type no.		Price group I	
33.0 cm deep	158,4 cm (105,6 + 52,8 cm) – as illustrated 211,2 cm (70,4 + 70,4 + 70,4 cm) 6	5709101 5712101		- -	
45.0 cm deep	158,4 cm (105,6 + 52,8 cm) – as illustrated 211,2 cm (70,4 + 70,4 + 70,4 cm) 6	5709201 5712201		- -	
<p>Important note: Cover shelves are essential and must be ordered separately (see pages 84-85)!</p>					

When used as wall units or stacked units:
Max. load per unit: 40 kg

Notes on delivery:
Please see here the information on range introduction pages.

Assembly notes for wall units:
Please be sure to note here the information and notes in the "Wall composition" chapter!

8 Raster units / highboards

SPECTRUM

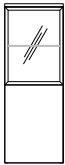
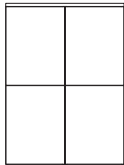
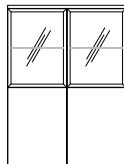
<p>8 Raster units / highboards 140.8 cm high (142.6 cm high incl. 1.8 cm high plinth adjusters), 33.0 or 45.0 cm deep</p> <p>Surcharges for ...</p> <p>... carcasses in price group II: see pages 98-101</p> <p>... fronts in Design Plain (A) in price group II: see pages 102-103</p> <p>... fronts in Design Rear-lacquered glass (B) see page 104</p> <p>... fronts in Design Slat (C): see page 105</p> <p>... fronts in Design Glass (D) – panel: see page 106</p> <p>... fronts in Design Glass (D) – veneer-covered aluminium frame: see page 106</p> <p>... drawers (instead of flaps): see page 106</p>	<p>2 doors in Design Plain (A)</p> 				
		Width	Type no.		Price group I
			Door hinge left	Door hinge right	
	33.0 cm deep	35,2 cm 52,8 cm – as illustrated 70,4 cm	5702103 5703103 5704103	5702104 5703104 5704104	- - -
	45.0 cm deep	35,2 cm 52,8 cm – as illustrated 70,4 cm	5702203 5703203 5704203	5702204 5703204 5704204	- - -
	<p>1 glass door in Design Glass (D) and 1 door in Design Plain (A)</p> 				
		Width	Type no.		Price group I
			Door hinge left	Door hinge right	
	33.0 cm deep	35,2 cm 52,8 cm – as illustrated 70,4 cm	5702163 5703163 5704163	5702164 5703164 5704164	- - -
	45.0 cm deep	35,2 cm 52,8 cm – as illustrated 70,4 cm	5702263 5703263 5704263	5702264 5703264 5704264	- - -
<p>Important note: Cover shelves are essential and must be ordered separately (see pages 84-85)!</p>	<p>4 doors in Design Plain (A)</p>  <p>This unit in 105.6 cm width cannot be fitted as a wall unit!</p>				
		Width (individual unit widths)	Type no.		Price group I
	33.0 cm deep	70,4 cm 105,6 cm – as illustrated 140,8 cm (70,4 + 70,4 cm)	5704115 5706115 5708102		- - -
	45.0 cm deep	70,4 cm 105,6 cm – as illustrated 140,8 cm (70,4 + 70,4 cm)	5704215 5706215 5708202		- - -
	<p>2 glass doors in Design Glass (D) and 2 doors in Design Plain (A)</p> 				
		Width (individual unit widths)	Type no.		Price group I
	33.0 cm deep	70,4 cm 105,6 cm – as illustrated 140,8 cm (70,4 + 70,4 cm)	5704175 5706175 5708162		- - -
	45.0 cm deep	70,4 cm 105,6 cm – as illustrated 140,8 cm (70,4 + 70,4 cm)	5704275 5706275 5708262		- - -

When used as wall units or stacked units:
Max. load per unit: 40 kg

8 Raster units / highboards

Lamps: see page 97

8 Raster units / highboards
 140.8 cm high
 (142.6 cm high incl. 1.8 cm high plinth adjusters),
33.0 or 45.0 cm deep

Surcharges for ...

... carcasses in price group II:
 see pages 98-101

... fronts in Design Plain (A) in price group II:
 see pages 102-103

... fronts in Design Rear-lacquered glass (B)
 see page 104

... fronts in Design Slat (C):
 see page 105

... fronts in Design Glass (D) – panel:
 see page 106

... fronts in Design Glass (D) – veneer-covered aluminium frame:
 see page 106

... drawers (instead of flaps):
 see page 106

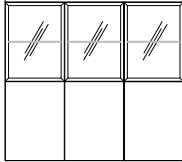
6 doors in Design Plain (A)			
			
This unit in 158.4 cm width cannot be fitted as a wall unit!			
Width (individual unit widths)		Type no.	Price group I
33.0 cm deep	158,4 cm (105,6 + 52,8 cm) – as illustrated	4	5709102
	211,2 cm (70,4 + 70,4 + 70,4 cm)	6	5712102
45.0 cm deep	158,4 cm (105,6 + 52,8 cm) – as illustrated	4	5709202
	211,2 cm (70,4 + 70,4 + 70,4 cm)	6	5712202
3 glass doors in Design Glass (D) and 3 doors in Design Plain (A)			
			
Width (individual unit widths)		Type no.	Price group I
33.0 cm deep	158,4 cm (105,6 + 52,8 cm) – as illustrated	5	5709162
	211,2 cm (70,4 + 70,4 + 70,4 cm)	6	5712162
45.0 cm deep	158,4 cm (105,6 + 52,8 cm) – as illustrated	5	5709262
	211,2 cm (70,4 + 70,4 + 70,4 cm)	6	5712262

Important note:
Cover shelves are essential and must be ordered separately (see pages 84-85)!

When used as wall units or stacked units:
 Max. load per unit: 40 kg

Notes on delivery:
Please see here the information on range introduction pages.

Assembly notes for wall units:
Please be sure to note here the information and notes in the "Wall composition" chapter!

8 Raster units / highboards

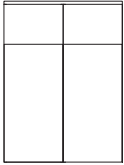
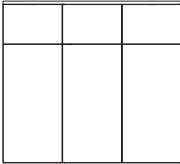
<p>8 Raster units / highboards 140.8 cm high (142.6 cm high incl. 1.8 cm high plinth adjusters), 33.0 or 45.0 cm deep</p> <p>Surcharges for ...</p> <p>... carcasses in price group II: see pages 98-101</p> <p>... fronts in Design Plain (A) in price group II: see pages 102-103</p> <p>... fronts in Design Rear-lacquered glass (B) see page 104</p> <p>... fronts in Design Slat (C): see page 105</p> <p>... fronts in Design Glass (D) – panel: see page 106</p> <p>... fronts in Design Glass (D) – veneer-covered aluminium frame: see page 106</p> <p>... drawers (instead of flaps): see page 106</p> <p>Important note: Cover shelves are essential and must be ordered separately (see pages 84-85)!</p>	<p>1 flap and 1 door in Design Plain (A)</p>  <p>This unit in 105.6 cm width cannot be fitted as a wall unit!</p>				
		Width	Type no.		Price group I
			Door hinge left	Door hinge right	
	33.0 cm deep	35,2 cm 52,8 cm – as illustrated 70,4 cm – 2 doors 105,6 cm – 2 doors	5702107 5703107	5702108 5703108 5704107 5706107	- - - -
	45.0 cm deep	35,2 cm 52,8 cm – as illustrated 70,4 cm – 2 doors 105,6 cm – 2 doors	5702207 5703207	5702208 5703208 5704207 5706207	- - - -
	<p>2 flaps and 2 doors in Design Plain (A)</p> 				
		Width (individual unit widths)	Type no.		Price group I
	33.0 cm deep	105,6 cm – as illustrated 140,8 cm (70,4 + 70,4 cm)	3 4	5706116 5708103	- -
	45.0 cm deep	105,6 cm – as illustrated 140,8 cm (70,4 + 70,4 cm)	3 4	5706216 5708203	- -
	<p>3 flaps and 3 doors in Design Plain (A)</p> 				
	Width (individual unit widths)	Type no.		Price group I	
33.0 cm deep	158,4 cm (105,6 + 52,8 cm) – as illustrated 211,2 cm (70,4 + 70,4 + 70,4 cm)	5 6	5709103 5712103	- -	
45.0 cm deep	158,4 cm (105,6 + 52,8 cm) – as illustrated 211,2 cm (70,4 + 70,4 + 70,4 cm)	5 6	5709203 5712203	- -	

When used as wall units or stacked units:
Max. load per unit: 40 kg

8 Raster units / highboards

Lamps: see page 97

<p>8 Raster units / highboards 140.8 cm high (142.6 cm high incl. 1.8 cm high plinth adjusters), 33.0 or 45.0 cm deep</p> <p>Surcharges for ...</p> <p>... carcasses in price group II: see pages 98-101</p> <p>... fronts in Design Plain (A) in price group II: see pages 102-103</p> <p>... fronts in Design Rear-lacquered glass (B) see page 104</p> <p>... fronts in Design Slat (C): see page 105</p> <p>... fronts in Design Glass (D) – panel: see page 106</p> <p>... fronts in Design Glass (D) – veneer-covered aluminium frame: see page 106</p> <p>... drawers (instead of flaps): see page 106</p>	<p>1 door and 1 flap in Design Plain (A)</p> <p>This unit in 105.6 cm width cannot be fitted as a wall unit!</p>				
		Width	Type no.		Price group I
			Door hinge left	Door hinge right	
	33.0 cm deep	35,2 cm 52,8 cm – as illustrated 70,4 cm – 2 doors 105,6 cm – 2 doors	5702105 5703105	5702106 5703106 5704105 5706105	- - - -
	45.0 cm deep	35,2 cm 52,8 cm – as illustrated 70,4 cm – 2 doors 105,6 cm – 2 doors	5702205 5703205	5702206 5703206 5704205 5706205	- - - -
	<p>1 glass door in Design Glass (D) and 1 flap in Design Plain (A)</p>				
		Width	Type no.		Price group I
			Door hinge left	Door hinge right	
	33.0 cm deep	35,2 cm 52,8 cm – as illustrated	5702165 5703165	5702166 5703166	- -
	45.0 cm deep	35,2 cm 52,8 cm – as illustrated	5702265 5703265	5702266 5703266	- -
<p>2 glass doors in Design Glass (D) and 2 flaps in Design Plain (A)</p>					
	Width	Type no.		Price group I	
33.0 cm deep	70,4 cm 105,6 cm – as illustrated	3	5704165 5706165	- -	
45.0 cm deep	70,4 cm 105,6 cm – as illustrated	3	5704265 5706265	- -	
<p>Important note: Cover shelves are essential and must be ordered separately (see pages 84-85)!</p>					



When used as wall units or stacked units:
Max. load per unit: 40 kg

Notes on delivery:
Please see here the information on range introduction pages.

Assembly notes for wall units:
Please be sure to note here the information and notes in the "Wall composition" chapter!

8 Raster units / highboards

SPECTRUM

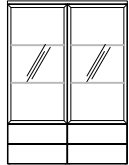
<p>8 Raster units / highboards 140.8 cm high (142.6 cm high incl. 1.8 cm high plinth adjusters), 33.0 or 45.0 cm deep</p> <p>Surcharges for ...</p> <p>... carcasses in price group II: see pages 98-101</p> <p>... fronts in Design Plain (A) in price group II: see pages 102-103</p> <p>... fronts in Design Rear-lacquered glass (B) see page 104</p> <p>... fronts in Design Slat (C): see page 105</p> <p>... fronts in Design Glass (D) – panel: see page 106</p> <p>... fronts in Design Glass (D) – veneer-covered aluminium frame: see page 106</p> <p>... drawers (instead of flaps): see page 106</p> <p>Important note: Cover shelves are essential and must be ordered separately (see pages 84-85)!</p> <p>When used as wall units or stacked units: Max. load per unit: 40 kg</p>	<p>1 door and 2 drawers in Design Plain (A)</p>  <p>This unit in 105.6 cm width cannot be fitted as a wall unit!</p>				
	Width		Type no.		Price group I
			Door hinge left	Door hinge right	
	33.0 cm deep	35,2 cm	5702111	5702112	-
		52,8 cm – as illustrated	5703111	5703112	-
		70,4 cm – 2 doors	5704111		-
		105,6 cm – 2 doors	5706111		-
	45.0 cm deep	35,2 cm	5702211	5702212	-
		52,8 cm – as illustrated	5703211	5703212	-
		70,4 cm – 2 doors	5704211		-
	105,6 cm – 2 doors	5706211		-	
<p>1 glass door in Design Glass (D) and 2 drawers in Design Plain (A)</p> 					
Width		Type no.		Price group I	
		Door hinge left	Door hinge right		
33.0 cm deep	35,2 cm	5702171	5702172	-	
	52,8 cm – as illustrated	5703171	5703172	-	
45.0 cm deep	35,2 cm	5702271	5702272	-	
	52,8 cm – as illustrated	5703271	5703272	-	
<p>2 glass doors in Design Glass (D) and 4 drawers in Design Plain (A)</p> 					
Width		Type no.		Price group I	
33.0 cm deep	70,4 cm		5704171	-	
	105,6 cm – as illustrated	3	5706171	-	
45.0 cm deep	70,4 cm		5704271	-	
	105,6 cm – as illustrated	3	5706271	-	

8 Raster units / highboards

Lamps: see page 97

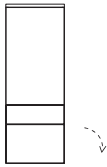
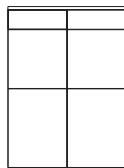
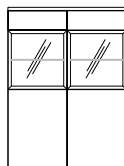
<p>8 Raster units / highboards 140.8 cm high (142.6 cm high incl. 1.8 cm high plinth adjusters), 33.0 or 45.0 cm deep</p> <p>Surcharges for ...</p> <p>... carcasses in price group II: see pages 98-101</p> <p>... fronts in Design Plain (A) in price group II: see pages 102-103</p> <p>... fronts in Design Rear-lacquered glass (B) see page 104</p> <p>... fronts in Design Slat (C): see page 105</p> <p>... fronts in Design Glass (D) – panel: see page 106</p> <p>... fronts in Design Glass (D) – veneer-covered aluminium frame: see page 106</p> <p>... drawers (instead of flaps): see page 106</p> <p>Important note: Cover shelves are essential and must be ordered separately (see pages 84-85)!</p>	<p>1 door, 1 drawer and 1 flap in Design Plain (A)</p>  <p>This unit in 105.6 cm width cannot be fitted as a wall unit!</p>				
		Width	Type no.		Price group I
			Door hinge left	Door hinge right	
	33.0 cm deep	35,2 cm	5702109	5702110	-
		52,8 cm – as illustrated	5703109	5703110	-
		70,4 cm – 2 doors 105,6 cm – 2 doors	5704109 5706109		- -
	45.0 cm deep	35,2 cm	5702209	5702210	-
		52,8 cm – as illustrated	5703209	5703210	-
		70,4 cm – 2 doors 105,6 cm – 2 doors	5704209 5706209		- -
	<p>2 drawers and 4 doors in Design Plain (A)</p> 				
	Width	Type no.		Price group I	
33.0 cm deep	105,6 cm – as illustrated	5706104		-	
45.0 cm deep	105,6 cm – as illustrated	5706204		-	
<p>2 drawers and 2 doors in Design Plain (A) as well as 2 glass doors in Design Glass (D)</p> 					
	Width	Type no.		Price group I	
33.0 cm deep	105,6 cm – as illustrated	5706173		-	
45.0 cm deep	105,6 cm – as illustrated	5706273		-	

Notes on delivery:
Please see here the information on range introduction pages.

Assembly notes for wall units:
Please be sure to note here the information and notes in the "Wall composition" chapter!

8 Raster units / highboards

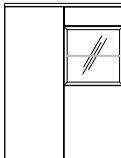
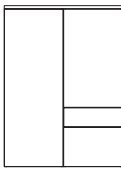
<p>8 Raster units / highboards 140.8 cm high (142.6 cm high incl. 1.8 cm high plinth adjusters), 33.0 or 45.0 cm deep</p> <p>Surcharges for ...</p> <p>... carcasses in price group II: see pages 98-101</p> <p>... fronts in Design Plain (A) in price group II: see pages 102-103</p> <p>... fronts in Design Rear-lacquered glass (B) see page 104</p> <p>... fronts in Design Slat (C): see page 105</p> <p>... fronts in Design Glass (D) – panel: see page 106</p> <p>... fronts in Design Glass (D) – veneer-covered aluminium frame: see page 106</p> <p>... drawers (instead of flaps): see page 106</p> <p>Important note: Cover shelves are essential and must be ordered separately (see pages 84-85)!</p> <p>Mirror-image types are possible. Please add an „S“ to the type no. in this case.</p>	<p>2 doors and 1 drawer in Design Plain (A) as well as 1 glass door in Design Glass (D)</p> 			
		Width	Type no.	Price group I
	33.0 cm deep	105,6 cm – as illustrated	5706174	-
	45.0 cm deep	105,6 cm – as illustrated	5706274	-
	<p>2 doors, 1 drawer and 1 flap in Design Plain (A)</p> 			
		Width (individual unit widths)	Type no.	Price group I
	33.0 cm deep	105,6 cm – as illustrated 140,8 cm (70,4 + 70,4 cm)	5706117 5708117	- -
	45.0 cm deep	105,6 cm – as illustrated 140,8 cm (70,4 + 70,4 cm)	5706217 5708217	- -
	<p>When used as wall units or stacked units: Max. load per unit: 40 kg</p>			

8 Raster units / highboards

Lamps: see page 97

<p>8 Raster units / highboards 140.8 cm high (142.6 cm high incl. 1.8 cm high plinth adjusters), 33.0 or 45.0 cm deep</p> <p>Surcharges for ...</p> <p>... carcasses in price group II: see pages 98-101</p> <p>... fronts in Design Plain (A) in price group II: see pages 102-103</p> <p>... fronts in Design Rear-lacquered glass (B) see page 104</p> <p>... fronts in Design Slat (C): see page 105</p> <p>... fronts in Design Glass (D) – panel: see page 106</p> <p>... fronts in Design Glass (D) – veneer-covered aluminium frame: see page 106</p> <p>... drawers (instead of flaps): see page 106</p> <p>Important note: Cover shelves are essential and must be ordered separately (see pages 84-85)!</p> <p>Mirror-image types are possible. Please add an „S“ to the type no. in this case.</p>	2 doors and 1 flap in Design Plain (A)			
	Width (individual unit widths)			
	33.0 cm deep	105,6 cm – as illustrated	3	5706101
		140,8 cm (70,4 + 70,4 cm)	T 4	5708105
				Price group I
				-
				-
	45.0 cm deep	105,6 cm – as illustrated	3	5706201
		140,8 cm (70,4 + 70,4 cm)	T 4	5708205
			-	
			-	
1 door and 1 flap in Design Plain (A) as well as 1 glass door in Design Glass (D)				
Width (individual unit widths)				
33.0 cm deep	105,6 cm – as illustrated	3	5706161	
	140,8 cm (70,4 + 70,4 cm)	T 4	5708165	
			-	
			-	
45.0 cm deep	105,6 cm – as illustrated	3	5706261	
	140,8 cm (70,4 + 70,4 cm)	T 4	5708265	
			-	
			-	
2 doors and 2 drawers in Design Plain (A)				
Width (individual unit widths)				
33.0 cm deep	105,6 cm – as illustrated	3	5706102	
	140,8 cm (70,4 + 70,4 cm)	T 4	5708106	
			-	
			-	
45.0 cm deep	105,6 cm – as illustrated	3	5706202	
	140,8 cm (70,4 + 70,4 cm)	T 4	5708206	
			-	
			-	
1 door and 2 drawers in Design Plain (A) as well as 1 glass door in Design Glass (D)				
Width (individual unit widths)				
33.0 cm deep	105,6 cm – as illustrated	3	5706162	
	140,8 cm (70,4 + 70,4 cm)	T 4	5708166	
			-	
			-	
45.0 cm deep	105,6 cm – as illustrated	3	5706262	
	140,8 cm (70,4 + 70,4 cm)	T 4	5708266	
			-	
			-	

When used as wall units or stacked units:
Max. load per unit: 40 kg

Notes on delivery:
Please see here the information on range introduction pages.

Assembly notes for wall units:
Please be sure to note here the information and notes in the "Wall composition" chapter!

8 Raster units / highboards

SPECTRUM

<p>8 Raster units / highboards 140.8 cm high (142.6 cm high incl. 1.8 cm high plinth adjusters), 33.0 or 45.0 cm deep</p> <p>Surcharges for ...</p> <p>... carcasses in price group II: see pages 98-101</p> <p>... fronts in Design Plain (A) in price group II: see pages 102-103</p> <p>... fronts in Design Rear-lacquered glass (B) see page 104</p> <p>... fronts in Design Slat (C): see page 105</p> <p>... fronts in Design Glass (D) – panel: see page 106</p> <p>... fronts in Design Glass (D) – veneer-covered aluminium frame: see page 106</p> <p>... drawers (instead of flaps): see page 106</p> <p>Important note: Cover shelves are essential and must be ordered separately (see pages 84-85)!</p> <p>Mirror-image types are possible. Please add an „S“ to the type no. in this case.</p>	3 doors and 4 drawers in Design Plain (A)			
	Width (individual unit widths)			
	33.0 cm deep	105,6 cm – as illustrated	3	5706103
		140,8 cm (70,4 + 70,4 cm)	T 4	5708107
				Type no.
				Price group I
	45.0 cm deep	105,6 cm – as illustrated	3	5706203
		140,8 cm (70,4 + 70,4 cm)	T 4	5708207
				Type no.
			Price group I	
2 doors and 4 drawers in Design Plain (A) as well as 1 glass door in Design Glass (D)				
Width (individual unit widths)				
33.0 cm deep	105,6 cm – as illustrated	3	5706163	
	140,8 cm (70,4 + 70,4 cm)	T 4	5708167	
			Type no.	
			Price group I	
45.0 cm deep	105,6 cm – as illustrated	3	5706263	
	140,8 cm (70,4 + 70,4 cm)	T 4	5708267	
			Type no.	
			Price group I	
5 doors and 4 drawers in Design Plain (A)				
Width (individual unit widths)				
33.0 cm deep	158,4 cm (105,6 + 52,8 cm) – as illustrated	5	5709107	
	211,2 cm (70,4 + 70,4 + 70,4 cm)	T 6	5712107	
			Type no.	
			Price group I	
45.0 cm deep	158,4 cm (105,6 + 52,8 cm) – as illustrated	5	5709207	
	211,2 cm (70,4 + 70,4 + 70,4 cm)	T 6	5712207	
			Type no.	
			Price group I	
2 glass doors in Design Glass (D) as well as 3 doors and 4 drawers in Design Plain (A)				
Width (individual unit widths)				
33.0 cm deep	158,4 cm (105,6 + 52,8 cm) – as illustrated	5	5709167	
	211,2 cm (70,4 + 70,4 + 70,4 cm)	T 6	5712167	
			Type no.	
			Price group I	
45.0 cm deep	158,4 cm (105,6 + 52,8 cm) – as illustrated	5	5709267	
	211,2 cm (70,4 + 70,4 + 70,4 cm)	T 6	5712267	
			Type no.	
			Price group I	
<p>When used as wall units or stacked units: Max. load per unit: 40 kg</p>				

Notes on delivery:
Please see here the information on range introduction pages.

Assembly notes for wall units:
Please be sure to note here the information and notes in the "Wall composition" chapter!

3

4

10 Raster units / single units

SPECTRUM

<p>10 Raster units / single units 176.0 cm high (177.8 cm high incl. 1.8 cm high plinth adjusters), 45.0 cm deep</p> <p>Surcharges for ...</p> <p>... carcasses in price group II: see pages 98-101</p> <p>... fronts in Design Plain (A) in price group II: see pages 102-103</p> <p>... fronts in Design Rear-lacquered glass (B) see page 104</p> <p>... fronts in Design Slat (C): see page 105</p> <p>... fronts in Design Glass (D) – panel: see page 106</p> <p>... fronts in Design Glass (D) – veneer-covered aluminium frame: see page 106</p> <p>... drawers (instead of flaps): see page 106</p> <p>Important note: Cover shelves are essential and must be ordered separately (see pages 84-85)!</p>	1 door in Design Plain (A)				
		Width	Type no.		Price group I
			Door hinge left	Door hinge right	
	45.0 cm deep	35,2 cm	5802201	5802202	-
		52,8 cm – as illustrated	5803201	5803202	-
		70,4 cm	5804201	5804202	-
	2 doors in Design Plain (A)				
		Width	Type no.		Price group I
		Door hinge left	Door hinge right		
45.0 cm deep	35,2 cm	5802203	5802204	-	
	52,8 cm – as illustrated	5803203	5803204	-	
	70,4 cm	5804203	5804204	-	
1 glass door in Design Glass (D) and 1 door in Design Plain (A)					
	Width	Type no.		Price group I	
		Door hinge left	Door hinge right		
45.0 cm deep	35,2 cm	5802261	5802262	-	
	52,8 cm – as illustrated	5803261	5803262	-	
	70,4 cm	5804261	5804262	-	
2 doors in Design Plain (A) and 1 glass door in Design Glass (D)					
	Width	Type no.		Price group I	
		Door hinge left	Door hinge right		
45.0 cm deep	35,2 cm	5802265	5802266	-	
	52,8 cm – as illustrated	5803265	5803266	-	
	70,4 cm				
<p>When used as wall units or stacked units: Max. load per unit: 40 kg</p>					

10 Raster units / single units

Lamps: see page 97

10 Raster units / single units
176.0 cm high
(177.8 cm high incl. 1.8 cm high plinth adjusters),
45.0 cm deep

Surcharges for ...

... carcasses in price group II:
see pages 98-101

... fronts in Design Plain (A)
in price group II:
see pages 102-103

... fronts in Design Rear-lacquered glass (B)
see page 104

... fronts in Design Slat (C):
see page 105

... fronts in Design Glass (D)
– panel:
see page 106

... fronts in Design Glass (D)
– veneer-covered aluminium frame:
see page 106

... drawers (instead of flaps):
see page 106

Important note:
Cover shelves are essential and must be ordered separately (see pages 84-85)!

1 door and 1 flap in Design Plain (A)

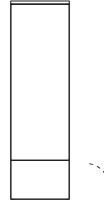

45.0 cm deep	Width	Type no.		Price group I
		Door hinge left	Door hinge right	
	35,2 cm	5802205	5802206	-
	52,8 cm – as illustrated	5803205	5803206	-
	70,4 cm	5804205	5804206	-

1 door and 2 drawers in Design Plain (A)



45.0 cm deep	Width	Type no.		Price group I
		Door hinge left	Door hinge right	
	35,2 cm	5802209	5802210	-
	52,8 cm – as illustrated	5803209	5803210	-
	70,4 cm	5804209	5804210	-

1 door, 2 drawers and 1 flap in Design Plain (A)

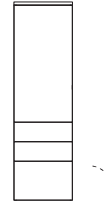

45.0 cm deep	Width	Type no.		Price group I
		Door hinge left	Door hinge right	
	35,2 cm	5802207	5802208	-
	52,8 cm – as illustrated	5803207	5803208	-
	70,4 cm	5804207	5804208	-

1 glass door in Design Glass (D) as well as 2 drawers and 1 flap in Design Plain (A)

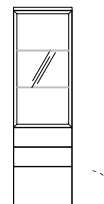

45.0 cm deep	Width	Type no.		Price group I
		Door hinge left	Door hinge right	
	35,2 cm	5802263	5802264	-
	52,8 cm – as illustrated	5803263	5803264	-
	70,4 cm	5804263	5804264	-

When used as wall units or stacked units:
Max. load per unit: 40 kg

Notes on delivery:
Please see here the information on range introduction pages.

Assembly notes for wall units:
Please be sure to note here the information and notes in the "Wall composition" chapter!

10 Raster units / single units

10 Raster units / single units
176.0 cm high
(177.8 cm high incl. 1.8 cm high plinth adjusters),
45.0 cm deep

Surcharges for ...

... carcasses in price group II:
see pages 98-101

... fronts in Design Plain (A) in price group II:
see pages 102-103

... fronts in Design Rear-lacquered glass (B)
see page 104

... fronts in Design Slat (C):
see page 105

... fronts in Design Glass (D) – panel:
see page 106

... fronts in Design Glass (D) – veneer-covered aluminium frame:
see page 106

... drawers (instead of flaps):
see page 106

1 door and 2 flaps in Design Plain (A)

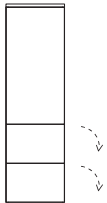

45.0 cm deep	Width	Type no.		Price group I
		Door hinge left	Door hinge right	
	35,2 cm	5802211	5802212	-
	52,8 cm – as illustrated	5803211	5803212	-
	70,4 cm	5804211	5804212	-

1 glass door in Design Glass (D) and 2 flaps in Design Plain (A)

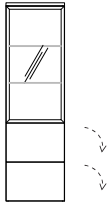

45.0 cm deep	Width	Type no.		Price group I
		Door hinge left	Door hinge right	
	35,2 cm	5802267	5802268	-
	52,8 cm – as illustrated	5803267	5803268	-
	70,4 cm	5804267	5804268	-

Important note:
Cover shelves are essential and must be ordered separately (see pages 84-85)!

When used as wall units or stacked units:
Max. load per unit: 40 kg

10 Raster units / single units

Lamps: see page 97

10 Raster units / single units
 176.0 cm high
 (177.8 cm high incl. 1.8 cm high plinth adjusters),
45.0 cm deep

Surcharges for ...

... carcasses in price group II:
 see pages 98-101

... fronts in Design Plain (A) in price group II:
 see pages 102-103

... fronts in Design Rear-lacquered glass (B)
 see page 104

... fronts in Design Slat (C):
 see page 105

... fronts in Design Glass (D) – panel:
 see page 106

... fronts in Design Glass (D) – veneer-covered aluminium frame:
 see page 106

... drawers (instead of flaps):
 see page 106

Important note:
Cover shelves are essential and must be ordered separately (see pages 84-85)!

Mirror-image types are possible. Please add an „S“ to the type no. in this case.

2 doors and 2 flaps in Design Plain (A)

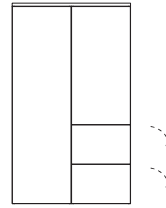

	Width (individual unit widths)	Type no.	Price group I
45.0 cm deep	70,4 cm	5804213	-
	105,6 cm (52,8 + 52,8 cm) – as illustrated	5806213	-

1 door and 2 flaps in Design Plain (A) as well as 1 glass door in Design Glass (D)

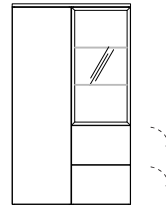

	Width (individual unit widths)	Type no.	Price group I
45.0 cm deep	70,4 cm	5804273	-
	105,6 cm (52,8 + 52,8 cm) – as illustrated	5806273	-

2 doors and 4 drawers in Design Plain (A)

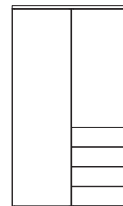

	Width (individual unit widths)	Type no.	Price group I
45.0 cm deep	70,4 cm	5804214	-
	105,6 cm (52,8 + 52,8 cm) – as illustrated	5806214	-

1 door and 4 drawers in Design Plain (A) as well as 1 glass door in Design Glass (D)



	Width (individual unit widths)	Type no.	Price group I
45.0 cm deep	70,4 cm	5804274	-
	105,6 cm (52,8 + 52,8 cm) – as illustrated	5806274	-





When used as wall units or stacked units:
 Max. load per unit: 40 kg

Notes on delivery:
Please see here the information on range introduction pages.

Assembly notes for wall units:
Please be sure to note here the information and notes in the "Wall composition" chapter!



12 Raster units / single units

SPECTRUM

<p>12 Raster units / single units 211.2 cm high (213.0 cm high incl. 1.8 cm high plinth adjusters), 45.0 cm deep</p> <p>12 Raster units cannot be planned as wall units!</p> <p>Surcharges for ...</p> <p>... carcasses in price group II: see pages 98-101</p> <p>... fronts in Design Plain (A) in price group II: see pages 102-103</p> <p>... fronts in Design Rear-lacquered glass (B) see page 104</p> <p>... fronts in Design Slat (C): see page 105</p> <p>... fronts in Design Glass (D) – panel: see page 106</p> <p>... fronts in Design Glass (D) – veneer-covered aluminium frame: see page 106</p> <p>... drawers (instead of flaps): see page 106</p> <p>Important note: Cover shelves are essential and must be ordered separately (see pages 84-85)!</p>	1 door in Design Plain (A)				
					
		Width	Type no.		Price group I
			Door hinge left	Door hinge right	
	45.0 cm deep	35,2 cm	5902201	5902202	-
		52,8 cm – as illustrated	5903201	5903202	-
		70,4 cm	5904201	5904202	-
	2 doors in Design Plain (A)				
					
		Width	Type no.		Price group I
		Door hinge left	Door hinge right		
45.0 cm deep	35,2 cm	5902219	5902220	-	
	52,8 cm – as illustrated	5903219	5903220	-	
	70,4 cm	5904219	5904220	-	
2 doors in Design Plain (A)					
					
	Width	Type no.		Price group I	
		Door hinge left	Door hinge right		
45.0 cm deep	35,2 cm	5902217	5902218	-	
	52,8 cm – as illustrated	5903217	5903218	-	
2 doors in Design Plain (A)					
					
	Width	Type no.		Price group I	
		Door hinge left	Door hinge right		
45.0 cm deep	35,2 cm	5902203	5902204	-	
	52,8 cm – as illustrated	5903203	5903204	-	
	70,4 cm	5904203	5904204	-	

12 Raster units / single units

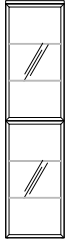
Lamps: see page 97

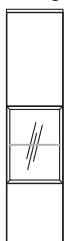
<p>12 Raster units / single units 211.2 cm high (213.0 cm high incl. 1.8 cm high plinth adjusters), 45.0 cm deep</p> <p>12 Raster units cannot be planned as wall units!</p> <p>Surcharges for ...</p> <p>... carcasses in price group II: see pages 98-101</p> <p>... fronts in Design Plain (A) in price group II: see pages 102-103</p> <p>... fronts in Design Rear-lacquered glass (B) see page 104</p> <p>... fronts in Design Slat (C): see page 105</p> <p>... fronts in Design Glass (D) – panel: see page 106</p> <p>... fronts in Design Glass (D) – veneer-covered aluminium frame: see page 106</p> <p>... drawers (instead of flaps): see page 106</p>	<p>2 glass doors in Design Glass (D)</p> 			
	<p>Width</p>	<p>Type no.</p>	<p>Price group I</p>	
<p>45,0 cm deep</p>	<p>35,2 cm</p> <p>52,8 cm – as illustrated</p> <p>70,4 cm</p>	<p>Door hinge left</p> <p>5902265</p> <p>5903265</p> <p>5904265</p>	<p>Door hinge right</p> <p>5902266</p> <p>5903266</p> <p>5904266</p>	<p>-</p> <p>-</p> <p>-</p>
<p>Important note: Cover shelves are essential and must be ordered separately (see pages 84-85)!</p>	<p>1 glass door in Design Glass (D) and 1 door in Design Plain (A)</p> 			
	<p>Width</p>	<p>Type no.</p>	<p>Price group I</p>	
<p>45,0 cm deep</p>	<p>35,2 cm</p> <p>52,8 cm – as illustrated</p> <p>70,4 cm</p>	<p>Door hinge left</p> <p>5902261</p> <p>5903261</p> <p>5904261</p>	<p>Door hinge right</p> <p>5902262</p> <p>5903262</p> <p>5904262</p>	<p>-</p> <p>-</p> <p>-</p>
	<p>2 doors in Design Plain (A) and 1 glass door in Design Glass (D)</p> 			
	<p>Width</p>	<p>Type no.</p>	<p>Price group I</p>	
<p>45,0 cm deep</p>	<p>35,2 cm</p> <p>52,8 cm – as illustrated</p> <p>70,4 cm</p>	<p>Door hinge left</p> <p>5902263</p> <p>5903263</p> <p>5904263</p>	<p>Door hinge right</p> <p>5902264</p> <p>5903264</p> <p>5904264</p>	<p>-</p> <p>-</p> <p>-</p>
	<p>2 doors in Design Plain (A) and 1 glass door in Design Glass (D)</p> 			
	<p>Width</p>	<p>Type no.</p>	<p>Price group I</p>	
<p>45,0 cm deep</p>	<p>35,2 cm</p> <p>52,8 cm – as illustrated</p>	<p>Door hinge left</p> <p>5902275</p> <p>5903275</p>	<p>Door hinge right</p> <p>5902276</p> <p>5903276</p>	<p>-</p> <p>-</p>

Notes on delivery:
Please see here the information on range introduction pages.

Assembly notes for wall units:
Please be sure to note here the information and notes in the "Wall composition" chapter!

12 Raster units / single units

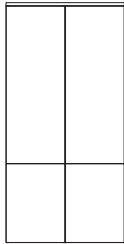
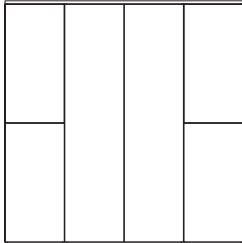
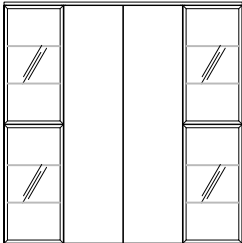
<p>12 Raster units / single units 211.2 cm high (213.0 cm high incl. 1.8 cm high plinth adjusters), 45.0 cm deep</p> <p>12 Raster units cannot be planned as wall units!</p> <p>Surcharges for ...</p> <p>... carcasses in price group II: see pages 98-101</p> <p>... fronts in Design Plain (A) in price group II: see pages 102-103</p> <p>... fronts in Design Rear-lacquered glass (B) see page 104</p> <p>... fronts in Design Slat (C): see page 105</p> <p>... fronts in Design Glass (D) – panel: see page 106</p> <p>... fronts in Design Glass (D) – veneer-covered aluminium frame: see page 106</p> <p>... drawers (instead of flaps): see page 106</p> <p>Important note: Cover shelves are essential and must be ordered separately (see pages 84-85)!</p>	<p>2 doors in Design Plain (A) and 1 glass door in Design Glass (D)</p> 					
	Width		Type no.		Price group I	
	45,0 cm deep	52,8 cm – as illustrated		Door hinge left 5903267	Door hinge right 5903268	-
	<p>4 doors in Design Plain (A)</p> 					
	Width (individual unit widths)		Type no.		Price group I	
	45,0 cm deep	105,6 cm (52,8 + 52,8 cm) – as illustrated		5906203		-
		140,8 cm (70,4 + 70,4 cm)		5908203		-
<p>6 doors in Design Plain (A)</p> 						
Width (individual unit widths)		Type no.		Price group I		
45,0 cm deep	211,2 cm (52,8 + 105,6 + 52,8 cm) – as illustrated		5912201		-	
<p>4 glass doors in Design Glass (D) and 2 doors in Design Plain (A)</p> 						
Width (individual unit widths)		Type no.		Price group I		
45,0 cm deep	211,2 cm (52,8 + 105,6 + 52,8 cm) – as illustrated		5912261		-	

12 Raster units / single units

Lamps: see page 97

12 Raster units / single units
 211.2 cm high
 (213.0 cm high incl. 1.8 cm high plinth adjusters),
 45.0 cm deep

12 Raster units cannot be planned as wall units!

Surcharges for ...

... carcasses in price group II: see pages 98-101

... fronts in Design Plain (A) in price group II: see pages 102-103

... fronts in Design Rear-lacquered glass (B) see page 104

... fronts in Design Slat (C): see page 105

... fronts in Design Glass (D) – panel: see page 106

... fronts in Design Glass (D) – veneer-covered aluminium frame: see page 106

... drawers (instead of flaps): see page 106

Important note:
Cover shelves are essential and must be ordered separately (see pages 84-85)!

1 glass door in Design Glass (D) as well as 1 flap and 1 door in Design Plain (A)

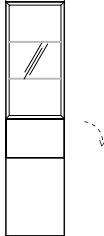

	Width	Type no.		Price group I
		Door hinge left	Door hinge right	
45.0 cm deep	52,8 cm – as illustrated	5903269	5903270	-

--	--	--	--

1 glass door in Design Glass (D) as well as 2 drawers and 1 door in Design Plain (A)



	Width	Type no.		Price group I
		Door hinge left	Door hinge right	
45.0 cm deep	52,8 cm – as illustrated	5903271	5903272	-

--	--	--	--

1 door, 1 drawer and 1 flap in Design Plain (A) as well as 1 glass door in Design Glass (D)

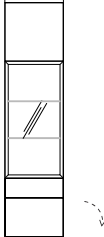

	Width	Type no.		Price group I
		Door hinge left	Door hinge right	
45.0 cm deep	52,8 cm – as illustrated	5903273	5903274	-

--	--	--	--

1 flap and 1 door in Design Plain (A) as well as 1 glass door in Design Glass (D)

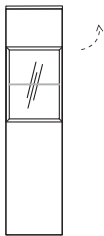

	Width	Type no.		Price group I
		Door hinge left	Door hinge right	
45.0 cm deep	35,2 cm 52,8 cm – as illustrated	5902277 5903277	5902278 5903278	- -

--	--	--	--

Notes on delivery:
Please see here the information on range introduction pages.

Assembly notes for wall units:
Please be sure to note here the information and notes in the "Wall composition" chapter!

12 Raster units / single units

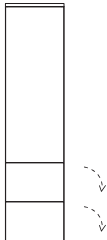
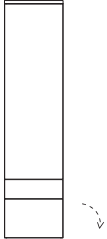
<p>12 Raster units / single units 211.2 cm high (213.0 cm high incl. 1.8 cm high plinth adjusters), 45.0 cm deep</p> <p>12 Raster units cannot be planned as wall units!</p> <p>Surcharges for ...</p> <p>... carcasses in price group II: see pages 98-101</p> <p>... fronts in Design Plain (A) in price group II: see pages 102-103</p> <p>... fronts in Design Rear-lacquered glass (B) see page 104</p> <p>... fronts in Design Slat (C): see page 105</p> <p>... fronts in Design Glass (D) – panel: see page 106</p> <p>... fronts in Design Glass (D) – veneer-covered aluminium frame: see page 106</p> <p>... drawers (instead of flaps): see page 106</p> <p>Important note: Cover shelves are essential and must be ordered separately (see pages 84-85)!</p>	<p>1 door and 1 flap in Design Plain (A)</p> 				
		Width	Type no.	Price group I	
			Door hinge left	Door hinge right	
	45.0 cm deep	35,2 cm	5902205	5902206	-
		52,8 cm – as illustrated	5903205	5903206	-
		70,4 cm	5904205	5904206	-
	<p>1 door and 2 flaps in Design Plain (A)</p> 				
		Width	Type no.	Price group I	
			Door hinge left	Door hinge right	
	45.0 cm deep	35,2 cm	5902213	5902214	-
	52,8 cm – as illustrated	5903213	5903214	-	
	70,4 cm	5904213	5904214	-	
<p>1 door, 1 drawer and 1 flap in Design Plain (A)</p> 					
	Width	Type no.	Price group I		
		Door hinge left	Door hinge right		
45.0 cm deep	35,2 cm	5902207	5902208	-	
	52,8 cm – as illustrated	5903207	5903208	-	
	70,4 cm	5904207	5904208	-	

12 Raster units / single units

Lamps: see page 97

12 Raster units / single units
 211.2 cm high
 (213.0 cm high incl. 1.8 cm high plinth adjusters),
45.0 cm deep

12 Raster units cannot be planned as wall units!

Surcharges for ...

... carcasses in price group II: see pages 98-101

... fronts in Design Plain (A) in price group II: see pages 102-103

... fronts in Design Rear-lacquered glass (B) see page 104

... fronts in Design Slat (C): see page 105

... fronts in Design Glass (D) – panel: see page 106

... fronts in Design Glass (D) – veneer-covered aluminium frame: see page 106

... drawers (instead of flaps): see page 106

Important note:
Cover shelves are essential and must be ordered separately (see pages 84-85)!

1 door and 2 drawers in Design Plain (A)



	Width	Type no.		Price group I
		Door hinge left	Door hinge right	
45.0 cm deep	35,2 cm	5902209	5902210	-
	52,8 cm – as illustrated	5903209	5903210	-
	70,4 cm	5904209	5904210	-

1 door and 3 drawers in Design Plain (A)



	Width	Type no.		Price group I
		Door hinge left	Door hinge right	
45.0 cm deep	35,2 cm	5902211	5902212	-
	52,8 cm – as illustrated	5903211	5903212	-
	70,4 cm	5904211	5904212	-

1 door and 4 drawers in Design Plain (A)



	Width	Type no.		Price group I
		Door hinge left	Door hinge right	
45.0 cm deep	35,2 cm	5902215	5902216	-
	52,8 cm – as illustrated	5903215	5903216	-
	70,4 cm	5904215	5904216	-

Notes on delivery:
Please see here the information on range introduction pages.

T

Assembly notes for wall units:
Please be sure to note here the information and notes in the "Wall composition" chapter!

3

4

12 Raster units / single units

SPECTRUM

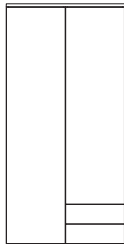
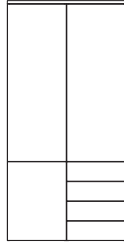
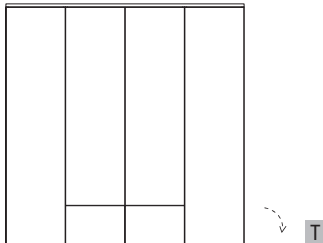
<p>12 Raster units / single units 211.2 cm high (213.0 cm high incl. 1.8 cm high plinth adjusters), 45.0 cm deep</p> <p>12 Raster units cannot be planned as wall units!</p> <p>Surcharges for ...</p> <p>... carcasses in price group II: see pages 98-101</p> <p>... fronts in Design Plain (A) in price group II: see pages 102-103</p> <p>... fronts in Design Rear-lacquered glass (B) see page 104</p> <p>... fronts in Design Slat (C): see page 105</p> <p>... fronts in Design Glass (D) – panel: see page 106</p> <p>... fronts in Design Glass (D) – veneer-covered aluminium frame: see page 106</p> <p>... drawers (instead of flaps): see page 106</p>	<p>2 doors and 2 drawers in Design Plain (A)</p> 		
	45.0 cm deep	<p>Width (individual unit widths)</p> <p>105,6 cm (52,8 + 52,8 cm) – as illustrated 140,8 cm (70,4 + 70,4 cm)</p>	<p>Type no.</p> <p>5906201 5908201</p>
<p>Important note: Cover shelves are essential and must be ordered separately (see pages 84-85)!</p> <p>Mirror-image types are possible. Please add an „S“ to the type no. in this case.</p>	<p>3 doors and 4 drawers in Design Plain (A)</p> 		
	45.0 cm deep	<p>Width (individual unit widths)</p> <p>105,6 cm (52,8 + 52,8 cm) – as illustrated 140,8 cm (70,4 + 70,4 cm)</p>	<p>Type no.</p> <p>5906202 5908202</p>
	<p>4 doors and 2 flaps in Design Plain (A)</p> 		
	45.0 cm deep	<p>Width (individual unit widths)</p> <p>211,2 cm (52,8 + 105,6 + 52,8 cm) – as illustrated</p>	<p>Type no.</p> <p>5912202</p>

6 Raster wall units

Lamps: see page 97

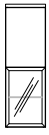
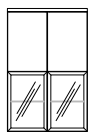
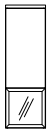
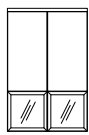
<p>6 Raster wall units 105.6 cm high, 33.0 or 45.0 cm deep</p> <p>Surcharges for ...</p> <p>... carcasses in price group II: see pages 98-101</p> <p>... fronts in Design Plain (A) in price group II: see pages 102-103</p> <p>... fronts in Design Rear-lacquered glass (B) see page 104</p> <p>... fronts in Design Slat (C): see page 105</p> <p>... fronts in Design Glass (D) – panel: see page 106</p> <p>... fronts in Design Glass (D) – veneer-covered aluminium frame: see page 106</p> <p>... drawers (instead of flaps): see page 106</p>	<p>1 door in Design Plain (A) and 1 glass door in Design Glass (D)</p> 					
		Width		Type no.	Price group I	
				Door hinge left	Door hinge right	
	33.0 cm deep	35,2 cm – as illustrated 52,8 cm		5502165 5503165	5502166 5503166	- -
	45.0 cm deep	35,2 cm – as illustrated 52,8 cm		5502265 5503265	5502266 5503266	- -
	<p>2 doors in Design Plain (A) and 2 glass doors in Design Glass (D)</p> 					
		Width		Type no.	Price group I	
	33.0 cm deep	70,4 cm – as illustrated 105,6 cm		5504164 5506164	- -	
	45.0 cm deep	70,4 cm – as illustrated 105,6 cm		5504264 5506264	- -	
	<p>Important note: Cover shelves are essential and must be ordered separately (see pages 84-85)!</p> <p>The majority of the units, low-, side- and highboards as well as the single units can also be planned as wall units. In this case, a wall bracket must be ordered in addition to the desired type.</p>	<p>1 door in Design Plain (A) and 1 glass door in Design Glass (D)</p> 				
		Width		Type no.	Price group I	
				Door hinge left	Door hinge right	
33.0 cm deep		35,2 cm – as illustrated		5502167	5502168	-
45.0 cm deep		35,2 cm – as illustrated		5502267	5502268	-
	<p>2 doors in Design Plain (A) and 2 glass doors in Design Glass (D)</p> 					
	Width		Type no.	Price group I		
33.0 cm deep	70,4 cm – as illustrated		5504166	-		
45.0 cm deep	70,4 cm – as illustrated		5504266	-		

Notes on delivery:
Please see here the information on range introduction pages.

Assembly notes for wall units:
Please be sure to note here the information and notes in the "Wall composition" chapter!

7 Raster wall units

SPECTRUM

7 Raster wall units 123.2 cm high, 33.0 or 45.0 cm deep		1 door in Design Plain (A) and 1 glass door in Design Glass (D)				
		Width	Type no.		Price group I	
<p>Surcharges for ...</p> <p>... carcasses in price group II: see pages 98-101</p> <p>... fronts in Design Plain (A) in price group II: see pages 102-103</p> <p>... fronts in Design Rear-lacquered glass (B) see page 104</p> <p>... fronts in Design Slat (C): see page 105</p> <p>... fronts in Design Glass (D) - panel: see page 106</p> <p>... fronts in Design Glass (D) - veneer-covered aluminium frame: see page 106</p> <p>... drawers (instead of flaps): see page 106</p>			Door hinge left	Door hinge right		
	33.0 cm deep	35,2 cm – as illustrated	5602161	5602162	-	
		52,8 cm	5603161	5603162	-	
	45.0 cm deep	35,2 cm – as illustrated	5602261	5602262	-	
		52,8 cm	5603261	5603262	-	
	2 doors in Design Plain (A) and 2 glass doors in Design Glass (D)					
		Width	Type no.		Price group I	
	33.0 cm deep	70,4 cm – as illustrated	5604161		-	
		105,6 cm	5606161		-	
	45.0 cm deep	70,4 cm – as illustrated	5604261		-	
105,6 cm		5606261		-		
1 door in Design Plain (A) and 1 glass door in Design Glass (D)						
	Width	Type no.		Price group I		
33.0 cm deep	35,2 cm – as illustrated	5602167		5602168		
45.0 cm deep	35,2 cm – as illustrated	5602267		5602268		
2 doors in Design Plain (A) and 2 glass doors in Design Glass (D)						
	Width	Type no.		Price group I		
33.0 cm deep	70,4 cm – as illustrated	5604164		-		
45.0 cm deep	70,4 cm – as illustrated	5604264		-		



Important note:
Cover shelves are essential and must be ordered separately (see pages 84-85)!

The majority of the units, low-, side- and highboards as well as the single units can also be planned as wall units. In this case, a wall bracket must be ordered in addition to the desired type.

When used as wall units or stacked units:
Max. load per unit: 40 kg



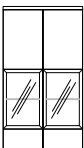

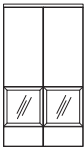
7 Raster wall units

Lamps: see page 97



<p>7 Raster wall units 123.2 cm high, 33.0 or 45.0 cm deep</p> <p>Surcharges for ...</p> <p>... carcasses in price group II: see pages 98-101</p> <p>... fronts in Design Plain (A) in price group II: see pages 102-103</p> <p>... fronts in Design Rear-lacquered glass (B) see page 104</p> <p>... fronts in Design Slat (C): see page 105</p> <p>... fronts in Design Glass (D) – panel: see page 106</p> <p>... fronts in Design Glass (D) – veneer-covered aluminium frame: see page 106</p> <p>... drawers (instead of flaps): see page 106</p> <p>Important note: Cover shelves are essential and must be ordered separately (see pages 84-85)!</p> <p>The majority of the units, low-, side- and highboards as well as the single units can also be planned as wall units. In this case, a wall bracket must be ordered in addition to the desired type.</p>	<p>1 door and 1 drawer in Design Plain (A) as well as 1 glass door in Design Glass (D)</p> 				
		Width	Type no.		Price group I
			Door hinge left	Door hinge right	
	33.0 cm deep	35,2 cm – as illustrated 52,8 cm	5602165 5603165	5602166 5603166	- -
	45.0 cm deep	35,2 cm – as illustrated 52,8 cm	5602265 5603265	5602266 5603266	- -
	<p>2 doors and 2 drawers in Design Plain (A) as well as 2 glass doors in Design Glass (D)</p> 				
		Width	Type no.		Price group I
	33.0 cm deep	70,4 cm – as illustrated 105,6 cm	5604162 5606162		- -
	45.0 cm deep	70,4 cm – as illustrated 105,6 cm	5604262 5606262		- -
	<p>1 door and 1 drawer in Design Plain (A) as well as 1 glass door in Design Glass (D)</p> 				
	Width	Type no.		Price group I	
		Door hinge left	Door hinge right		
33.0 cm deep	35,2 cm – as illustrated	5602171	5602172	-	
45.0 cm deep	35,2 cm – as illustrated	5602271	5602272	-	
<p>2 doors and 2 drawers in Design Plain (A) as well as 2 glass doors in Design Glass (D)</p> 					
	Width	Type no.		Price group I	
33.0 cm deep	70,4 cm – as illustrated	5604163		-	
45.0 cm deep	70,4 cm – as illustrated	5604263		-	

Fitted shelves – behind doors and 3 Raster flaps

SPECTRUM

Fitted shelves – behind doors and 3 Raster flaps 1.9 cm thick (2.9 cm thick for 105.6 cm width) Depths: 27.5 cm (for 33.0 cm depth) or 39.5 cm (for 45.0 cm depth)	 for 35.2 cm width				 for 52.8 cm width			
	for 33.0 cm depth		for 45.0 cm depth		for 33.0 cm depth		for 45.0 cm depth	
	13000212		13000222		13000312		13000322	
	Price gr. I II		-		-		-	
	 for 70.4 cm width				 for 105.6 cm width			
	for 33.0 cm depth		for 45.0 cm depth		for 33.0 cm depth		for 45.0 cm depth	
	13000412		13000422		13000612		13000622	
	Price gr. I II		-		-		-	

Fitted glass shelves – behind doors

Fitted glass shelves (clear glass) – behind doors 0.8 cm thick Depths: 26.4 cm (for 33.0 cm depth) or 38.4 cm (for 45.0 cm depth)	 for 35.2 cm width						 for 52.8 cm width		 for 70.4 cm width			
	for 33.0 cm depth		for 45.0 cm depth		for 33.0 cm depth		for 45.0 cm depth		for 33.0 cm depth		for 45.0 cm depth	
	13000213		13000223		13000313		13000323		13000414		13000424	
	Clear glass		-		-		-		-		-	

Cover panels for corner units

Cover and plinth shelves for corner units:
see pages **84-86**

Cover panels for corner units If Spectrum combinations are planned round corners with units, it is possible to include a cover panel for corner units. Only units of the same height can be planned round corners.								
	for 2 Raster height (35.2 cm high)	for 3 Raster height (52.8 cm high)	for 4 Raster height (70.4 cm high)	for 6 Raster height (105.6 cm high)	for 7 Raster height (123.2 cm high)	for 8 Raster height (140.8 cm high)	for 10 Raster height (176.0 cm high)	for 12 Raster height (211.2 cm high)
	24002000	24003000	24004000	24006000	24007000	24008000	24010000	24012000
Price gr. I II	-	-	-	-	-	-	-	

Slide-in rear walls for carcasses behind aluminium frame doors

Slide-in rear walls in Design Plain (A) for carcasses behind aluminium frame doors

1.3 cm thick

Slide-in rear walls can be fitted in carcasses behind aluminium frame doors. Shelves can be fitted anywhere. Later fitting of rear wall is possible.



Slide-in rear wall in Design Plain (A)

		for 2 Raster height (31.2 cm high)	for 3 Raster height (48.8 cm high)	for 4 Raster height (66.4 cm high)	for 6 Raster height (101.6 cm high)		
for 35.2 cm width	Price gr.	14020200	14030200	14040200	14060200		
	I II	- -	- -	- -	- -		
for 52.8 cm width	Price gr.	X		14040300	14060300		
	I II	X		- -	- -		
for 70.4 cm width	Price gr.	X		14040400	14060400		
	I II	X		- -	- -		

Slide-in rear walls in Design Rear-lacquered glass (B) or in Design Slat (C) for carcasses behind aluminium frame doors

0,3 cm thick in Design Rear-lacquered glass (B) resp. 1.2 cm thick in Design Slat (C)

Slide-in rear walls can be fitted in carcasses behind aluminium frame doors. Shelves can be fitted anywhere. Later fitting of rear wall is possible.



Slide-in rear wall in Design Rear-lacquered glass (B)

Slide-in rear wall in Design Slat (C)

		for 2 Raster height (31.2 cm high)	for 3 Raster height (48.8 cm high)	for 4 Raster height (66.4 cm high)	for 6 Raster height (101.6 cm high)	for 2 Raster height (31.2 cm high)	for 3 Raster height (48.8 cm high)	for 4 Raster height (66.4 cm high)	for 6 Raster height (101.6 cm high)
for 35.2 cm width	Price gr.	14020201	14030201	14040201	14060201	14020202	14030202	14040202	14060202
	I II	- -	- -	- -	- -	- -	- -	- -	- -
for 52.8 cm width	Price gr.	X		14040301	14060301	X		14060302	14060302
	I II	X		- -	- -	X		- -	- -
for 70.4 cm width	Price gr.	X		14040401	14060401	X		14040402	14060402
	I II	X		- -	- -	X		- -	- -

Open intermediate units in Design Plain (A)

33.0 or 45.0 cm deep

Open intermediate units consisting of top and bottom shelf, one side and rear wall; for fitting between two carcasses.

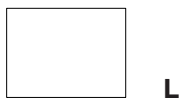

Open intermediate unit in Design Plain (A)

		35.2 cm high		52.8 cm high			
		33.0 cm deep	45.0 cm deep	33.0 cm deep	45.0 cm deep		
35.2 cm wide	Price gr.	41122110 L 41122120 R	41122210 L 41122220 R	41132110 L 41132120 R	41132210 L 41132220 R		
	I II	- -	- -	- -	- -		
52.8 cm wide	Price gr.	41123110 L 41123120 R	41123210 L 41123220 R	41133110 L 41133120 R	41133210 L 41133220 R		
	I II	- -	- -	- -	- -		

Open intermediate units in Design Rear-lacquered glass (B) or in Design Slat (C)

33.0 or 45.0 cm deep

Open intermediate units consisting of top and bottom shelf, one side and rear wall; for fitting between two carcasses.

Please note: With the open intermediate unit in Design Slat (C), only the rear wall and the side are in Design Slat (C).

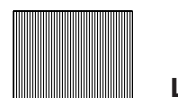

Open intermediate unit in Design Rear-lacquered glass (B)

Open intermediate unit in Design Slat (C)

		35.2 cm high		52.8 cm high		35.2 cm high		52.8 cm high	
		33.0 cm deep	45.0 cm deep	33.0 cm deep	45.0 cm deep	33.0 cm deep	45.0 cm deep	33.0 cm deep	45.0 cm deep
35.2 cm wide	Price gr.	41222110 L 41222120 R	41222210 L 41222220 R	41232110 L 41232120 R	41232210 L 41232220 R	41322110 L 41322120 R	41322210 L 41322220 R	41332110 L 41332120 R	41332210 L 41332220 R
	I II	- -	- -	- -	- -	- -	- -	- -	- -
52.8 cm wide	Price gr.	41223110 L 41223120 R	41223210 L 41223220 R	41233110 L 41233120 R	41233210 L 41233220 R	41323110 L 41323120 R	41323210 L 41323220 R	41333110 L 41333120 R	41333210 L 41333220 R
	I II	- -	- -	- -	- -	- -	- -	- -	- -

Cover shelves

Plinth shelves and legs are optional and can be ordered separately; see pages 86-87

Cover shelves (optionally in wood / lacquer version or of rear-lacquered glass) **are essential and must be ordered separately. If no further details are stated in the order, 2.8 cm thick cover shelves in wood / lacquer version are supplied.**

All units, low-, side- and highboards must be fitted with a cover shelf. If several units are planned adjacently, it is possible to fit a full-length cover shelf. The cover shelves are full-length up to a max. 211.2 cm width.

Cover shelves in wood / lacquer version (standard cover shelf)

2.8 cm thick; 33.0 or 45.0 cm deep



		for 35.2 cm width		for 52.8 cm width		for 70.4 cm width		for 88.0 cm width	
		33.0 cm deep	45.0 cm deep	33.0 cm deep	45.0 cm deep	33.0 cm deep	45.0 cm deep	33.0 cm deep	45.0 cm deep
		15000211	15000221	15000311	15000321	15000411	15000421	15000511	15000521
Price gr.		-	-	-	-	-	-	-	-
I		-	-	-	-	-	-	-	-
II		-	-	-	-	-	-	-	-
		for 105.6 cm width		for 123.2 cm width		for 140.8 cm width		for 158.4 cm width	
		33.0 cm deep	45.0 cm deep	33.0 cm deep	45.0 cm deep	33.0 cm deep	45.0 cm deep	33.0 cm deep	45.0 cm deep
		15000611	15000621	15000711	15000721	15000811	15000821	15000911	15000921
Price gr.		-	-	-	-	-	-	-	-
I		-	-	-	-	-	-	-	-
II		-	-	-	-	-	-	-	-
		for 176.0 cm width		for 193.6 cm width		for 211.2 cm width		Shelf extension for corner units	
		33.0 cm deep	45.0 cm deep	33.0 cm deep	45.0 cm deep	33.0 cm deep	45.0 cm deep	for all depths	
		15001011	15001021	15001111	15001121	15001211	15001221	75200000	
Price gr.		-	-	-	-	-	-	-	
I		-	-	-	-	-	-	-	
II		-	-	-	-	-	-	-	

Cover shelves in wood / lacquer version

1.0 cm thick; 33.0 or 45.0 cm deep



		for 35.2 cm width		for 52.8 cm width		for 70.4 cm width		for 88.0 cm width	
		33.0 cm deep	45.0 cm deep	33.0 cm deep	45.0 cm deep	33.0 cm deep	45.0 cm deep	33.0 cm deep	45.0 cm deep
		15000212	15000222	15000312	15000322	15000412	15000422	15000512	15000522
Price gr.		-	-	-	-	-	-	-	-
I		-	-	-	-	-	-	-	-
II		-	-	-	-	-	-	-	-
		for 105.6 cm width		for 123.2 cm width		for 140.8 cm width		for 158.4 cm width	
		33.0 cm deep	45.0 cm deep	33.0 cm deep	45.0 cm deep	33.0 cm deep	45.0 cm deep	33.0 cm deep	45.0 cm deep
		15000612	15000622	15000712	15000722	15000812	15000822	15000912	15000922
Price gr.		-	-	-	-	-	-	-	-
I		-	-	-	-	-	-	-	-
II		-	-	-	-	-	-	-	-
		for 176.0 cm width		for 193.6 cm width		for 211.2 cm width		Shelf extension for corner units	
		33.0 cm deep	45.0 cm deep	33.0 cm deep	45.0 cm deep	33.0 cm deep	45.0 cm deep	for all depths	
		15001012	15001022	15001112	15001122	15001212	15001222	75100000	
Price gr.		-	-	-	-	-	-	-	
I		-	-	-	-	-	-	-	
II		-	-	-	-	-	-	-	

Cover shelves

Cover shelves (optionally in wood / lacquer version or of rear-lacquered glass) **are essential and must be ordered separately. If no further details are stated in the order, 2.8 cm thick cover shelves in wood / lacquer version are supplied.**

All units, low-, side- and highboards must be fitted with a cover shelf. If several units are planned adjacently, it is possible to fit a full-length cover shelf. The cover shelves are full-length up to a max. 211.2 cm width.

Cover shelves of rear-lacquered glass

0.8 cm thick; 33.0 or 45.0 cm deep



		for 35.2 cm width		for 52.8 cm width		for 70.4 cm width		for 88.0 cm width	
		33.0 cm deep	45.0 cm deep	33.0 cm deep	45.0 cm deep	33.0 cm deep	45.0 cm deep	33.0 cm deep	45.0 cm deep
		15000213	15000223	15000313	15000323	15000413	15000423	15000513	15000523
Price gr.	I	-	-	-	-	-	-	-	-
	II	-	-	-	-	-	-	-	-
		for 105.6 cm width		for 123.2 cm width		for 140.8 cm width		for 158.4 cm width	
		33.0 cm deep	45.0 cm deep	33.0 cm deep	45.0 cm deep	33.0 cm deep	45.0 cm deep	33.0 cm deep	45.0 cm deep
		15000613	15000623	15000713	15000723	15000813	15000823	15000913	15000923
Price gr.	I	-	-	-	-	-	-	-	-
	II	-	-	-	-	-	-	-	-
		for 176.0 cm width		for 193.6 cm width		for 211.2 cm width		Shelf extension for corner units (not available in marble black and marble white)	
		33.0 cm deep	45.0 cm deep	33.0 cm deep	45.0 cm deep	33.0 cm deep	45.0 cm deep	for all depths	
		15001013	15001023	15001113	15001123	15001213	15001223	75300000	
Price gr.	I	-	-	-	-	-	-	-	
	II	-	-	-	-	-	-	-	

Wall brackets

If units are planned as wall units, a **wall bracket** must be ordered.

If units are stacked on top of one another, a wall bracket is only to be ordered for the stacked unit(s) if the stacked unit is wider than the floor unit resp. stacked in an off-set position.

Wall bracket

		for 35.2 cm width		for 52.8 cm width		for 70.4 cm width		for 88.0 cm width	
		4352		4528		4704		4880	
		-		-		-		-	
		for 105.6 cm width		for 123.2 cm width		for 140.8 cm width		for 158.4 cm width	
		4105		4123		4140		4158	
		-		-		-		-	
		for 176.0 cm width		for 193.6 cm width		for 211.2 cm width			
		4176		4193		4211			
		-		-		-			

Plinth shelves

Plinth shelves and legs are optional and can be ordered separately; see pages 86-87

Plinth shelves are optional and can be ordered separately.

All units, low-, side- and highboards can be fitted with an extra plinth shelf. If several units are planned adjacently, it is possible to fit a full-length plinth shelf. The plinth shelves are full-length up to a max. 211.2 cm width.

Plinth shelves in wood / lacquer version

2.8 cm thick; 33.0 or 45.0 cm deep



		for 35.2 cm width		for 52.8 cm width		for 70.4 cm width		for 88.0 cm width	
		33.0 cm deep	45.0 cm deep	33.0 cm deep	45.0 cm deep	33.0 cm deep	45.0 cm deep	33.0 cm deep	45.0 cm deep
		16000211	16000221	16000311	16000321	16000411	16000421	16000511	16000521
Price gr.		-	-	-	-	-	-	-	-
I		-	-	-	-	-	-	-	-
II		-	-	-	-	-	-	-	-

		for 105.6 cm width		for 123.2 cm width		for 140.8 cm width		for 158.4 cm width	
		33.0 cm deep	45.0 cm deep	33.0 cm deep	45.0 cm deep	33.0 cm deep	45.0 cm deep	33.0 cm deep	45.0 cm deep
		16000611	16000621	16000711	16000721	16000811	16000821	16000911	16000921
Price gr.		-	-	-	-	-	-	-	-
I		-	-	-	-	-	-	-	-
II		-	-	-	-	-	-	-	-

		for 176.0 cm width		for 193.6 cm width		for 211.2 cm width		Shelf extension for corner units	
		33.0 cm deep	45.0 cm deep	33.0 cm deep	45.0 cm deep	33.0 cm deep	45.0 cm deep	for all depths	
		16001011	16001021	16001111	16001121	16001211	16001221	75500000	
Price gr.		-	-	-	-	-	-	-	
I		-	-	-	-	-	-	-	
II		-	-	-	-	-	-	-	

Plinth shelves in wood / lacquer version

1.0 cm thick; 33.0 or 45.0 cm deep



		for 35.2 cm width		for 52.8 cm width		for 70.4 cm width		for 88.0 cm width	
		33.0 cm deep	45.0 cm deep	33.0 cm deep	45.0 cm deep	33.0 cm deep	45.0 cm deep	33.0 cm deep	45.0 cm deep
		16000212	16000222	16000312	16000322	16000412	16000422	16000512	16000522
Price gr.		-	-	-	-	-	-	-	-
I		-	-	-	-	-	-	-	-
II		-	-	-	-	-	-	-	-

		for 105.6 cm width		for 123.2 cm width		for 140.8 cm width		for 158.4 cm width	
		33.0 cm deep	45.0 cm deep	33.0 cm deep	45.0 cm deep	33.0 cm deep	45.0 cm deep	33.0 cm deep	45.0 cm deep
		16000612	16000622	16000712	16000722	16000812	16000822	16000912	16000922
Price gr.		-	-	-	-	-	-	-	-
I		-	-	-	-	-	-	-	-
II		-	-	-	-	-	-	-	-

		for 176.0 cm width		for 193.6 cm width		for 211.2 cm width		Shelf extension for corner units	
		33.0 cm deep	45.0 cm deep	33.0 cm deep	45.0 cm deep	33.0 cm deep	45.0 cm deep	for all depths	
		16001012	16001022	16001112	16001122	16001212	16001222	75400000	
Price gr.		-	-	-	-	-	-	-	
I		-	-	-	-	-	-	-	
II		-	-	-	-	-	-	-	

Legs are optional and can be ordered separately.

All units, low-, side- and highboards can be fitted on extra legs. In this case the plinth legs are omitted.

Legs straight BU 06 (set of 4)

15.0 cm high; for all depths;
optionally metal black or pure white

Please state the required version clearly in the order!



0081005

Side-panels

<p>Side-panels 2.8 cm thick; 30.3 cm deep</p> <p>Side-panels incl. 1.8 cm high plinth adjusters</p> <p>Please allow a 2.5 cm gap to the ceiling and at the side for assembly in each project!</p>							
		6 Raster (110.3 cm high)	7 Raster (127.9 cm high)	8 Raster (145.5 cm high)	9 Raster (163.1 cm high)	10 Raster (180.7 cm high)	12 Raster (215.9 cm high)
	Price gr. I II	31106001 - -	31107001 - -	31108001 - -	31109001 - -	31110001 - -	31112001 - -

Top side-panels



<p>Top side-panels 2.8 cm thick; 30.3 cm deep</p> <p>For fitting on top of units. The top side-panels are shortened free of charge – depending on the thickness of the selected cover shelf – to the appropriate height.</p> <p>Please allow a 2.5 cm gap to the ceiling and at the side for assembly in each project!</p>							
		for 6 Raster height	for 7 Raster height	for 8 Raster height	for 9 Raster height	for 10 Raster height	for 12 Raster height
	Price gr. I II	31306001 - -	31307001 - -	31308001 - -	31309001 - -	31310001 - -	31312001 - -

Wall side-panels

<p>Wall side-panels 2.8 cm thick; 30.3 cm deep</p> <p>Please allow a 2.5 cm gap to the ceiling and at the side for assembly in each project!</p> <p>The wall side-panels may only be fitted on absolutely solid walls. Gypsum or other light masonry is not suitable for this purpose.</p>							
		6 Raster (108.4 cm high)	7 Raster (126.0 cm high)	8 Raster (143.6 cm high)	9 Raster (161.2 cm high)	10 Raster (178.8 cm high)	
	Price gr. I II	31206001 - -	31207001 - -	31208001 - -	31209001 - -	31210001 - -	

Fitted wooden shelves for side-panels

SPECTRUM

Fitted wooden shelves for side-panels 1.2 or 2.8 cm thick; 30.2 cm deep 1.2 cm thick fitted shelves cannot be planned at the very bottom and at the very top of a side-panel column.	 35.2 cm wide 52.8 cm wide				Depth profiled fitted shelf  R 35.2 cm wide
	1.2 cm thick	2.8 cm thick	1.2 cm thick	2.8 cm thick	2.8 cm thick
Depth profiled fitted shelf for side-panels 2.8 cm thick; 21.9:30.3 cm deep	32600021 Price gr. I - II -	32100021 Price gr. I - II -	32600031 Price gr. I - II -	32100031 Price gr. I - II -	32200021 L 32300021 R Price gr. I - II -

Fitted wooden shelves for side-panels in front of niche rear wall

Fitted wooden shelves for side-panels in front of niche rear wall 1.2 or 2.8 cm thick; 28.0 cm deep 1.2 cm thick fitted shelves cannot be planned at the very bottom and at the very top of a side-panel column.	 35.2 cm wide 52.8 cm wide				
	1.2 cm thick	2.8 cm thick	1.2 cm thick	2.8 cm thick	
	32600022 Price gr. I - II -	32100022 Price gr. I - II -	32600032 Price gr. I - II -	32100032 Price gr. I - II -	

Wooden shelves for side-panels – behind doors

Wooden shelves for side-panels – behind doors 1.9 cm thick; 28.0 cm deep	 35.2 cm wide 52.8 cm wide				
		32400021 Price gr. I - II -		32400031 Price gr. I - II -	

Glass shelves for side-panels – behind doors





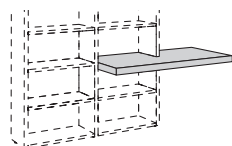
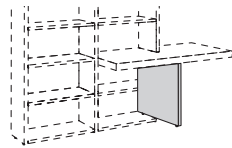

Glass shelves (clear glass) for side-panels – behind doors 0.6 cm thick; 28.0 cm deep If glass shelves for side-panels are included, fitted wooden shelves must also be included at the very top and bottom of this side-panel column for constructional reasons.	 Clear glass				
		35.2 cm wide 32500021 Price gr. I - II -		52.8 cm wide 32500031 Price gr. I - II -	

Work surface

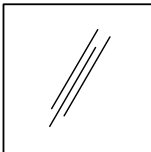
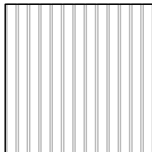
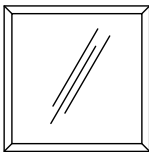
Work surface 3.8 cm thick; 45.0 cm deep 		176.0 cm wide
	34100101 Price gr. I - II -	
4 Raster lower side-panel for work surface 68.4 cm high incl. 1.8 cm high plinth adjusters; 2.8 cm thick; 45.0 cm deep 		34204001 Price gr. I - II -

Doors for side-panels

3 – 6 Raster doors

3 Raster doors = 52.4 cm high 4 Raster doors = 70.0 cm high 6 Raster doors = 105.2 cm high Front thickness: 2.3 cm to be fitted in front of side-panels		Design Plain (A)	Design Rear-lacquered glass (B)	Design Slat (C)	Design Glass (D)
					
3 Raster doors  for 35.2 cm width	Price gr. I II	21103021 L 21103022 R - -	21203021 L 21203022 R - -	21403021 L 21403022 R - -	21303021 L 21303022 R - -
 for 52.8 cm width	Price gr. I II	21103031 L 21103032 R - -	21203031 L 21203032 R - -	21403031 L 21403032 R - -	21303031 L 21303032 R - -
4 Raster doors  for 35.2 cm width	Price gr. I II	21104021 L 21104022 R - -	21204021 L 21204022 R - -	21404021 L 21404022 R - -	21304021 L 21304022 R - -
 for 52.8 cm width	Price gr. I II	21104031 L 21104032 R - -	21204031 L 21204032 R - -	21404031 L 21404032 R - -	21304031 L 21304032 R - -
6 Raster doors  for 35.2 cm width	Price gr. I II	21106021 L 21106022 R - -	21206021 L 21206022 R - -	21406021 L 21406022 R - -	21306021 L 21306022 R - -
 for 52.8 cm width	Price gr. I II	21106031 L 21106032 R - -	21206031 L 21206032 R - -	21406031 L 21406032 R - -	21306031 L 21306032 R - -

Niche rear walls for side-panels in Design Plain (A)

2.2 cm thick

Niche rear walls can be fitted between side-panels. Shelves can be fitted anywhere. Later fitting of rear wall is not possible. Rear walls with all-round cushioning brush.

When integrated LED spotlamps are fitted, the niche rear wall must be split at the height of the lamps. Please remember this when planning!

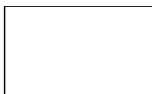

Niche rear wall in Design Plain (A)

		for 3 Raster height	for 4 Raster height	for 6 Raster height		
for 35.2 cm width	Price gr. I II	33103020 - -	33104020 - -	33106020 - -		
for 52.8 cm width	Price gr. I II	33103030 - -	33104030 - -	33106030 - -		

Niche rear walls for side-panels in Design Rear-lacquered glass (B) or in Design Slat (C)

2.2 cm thick

Niche rear walls can be fitted between side-panels. Shelves can be fitted anywhere. Later fitting of rear wall is not possible. Rear walls with all-round cushioning brush.

When integrated LED spotlamps are fitted, the niche rear wall must be split at the height of the lamps. Please remember this when planning!



Niche rear wall in Design Rear-lacquered glass (B)

Niche rear wall in Design Slat (C)

		for 3 Raster height	for 4 Raster height	for 6 Raster height	for 3 Raster height	for 4 Raster height	for 6 Raster height
for 35.2 cm width	Price gr. I II	33203020 - -	33204020 - -	33206020 - -	33403020 - -	33404020 - -	33406020 - -
for 52.8 cm width	Price gr. I II	33203030 - -	33204030 - -	33206030 - -	33403030 - -	33404030 - -	33406030 - -

TV wall panels in Design Plain (A)

TV wall panels in Design Plain (A)

2.3 cm thick (total depth incl. fittings: 8.3 cm)

TV wall panels consisting of 6 individual panels (dimensions of the individual panels: see illustrations) and all-round cover panel, cover panel with optional LED lamp; for fitting anywhere on walls. Changing versions within the individual panels are possible (see next page).

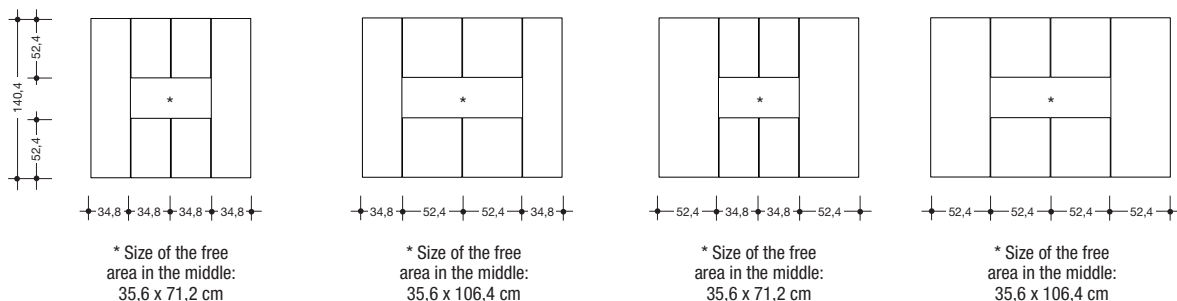

TV wall panel in Design Plain (A)

		140.8 cm wide	176.0 cm wide	176.0 cm wide	211.2 cm wide
140.4 cm high	Price gr.	43008080	43008101	43008102	43008120
		-	-	-	-
LED lamp for cover panel	LED lamps incl. foot switch. A radio remote control is possible for operation (against a surcharge).				
		for 140.8 cm width	for 176.0 cm width	for 176.0 cm width	for 211.2 cm width
		29,3 W	32,0 W	32,0 W	34,7 W
		0070151	0070152	0070152	0070153
		-	-	-	-

This product contains a light source of energy efficiency class D. 12 V.

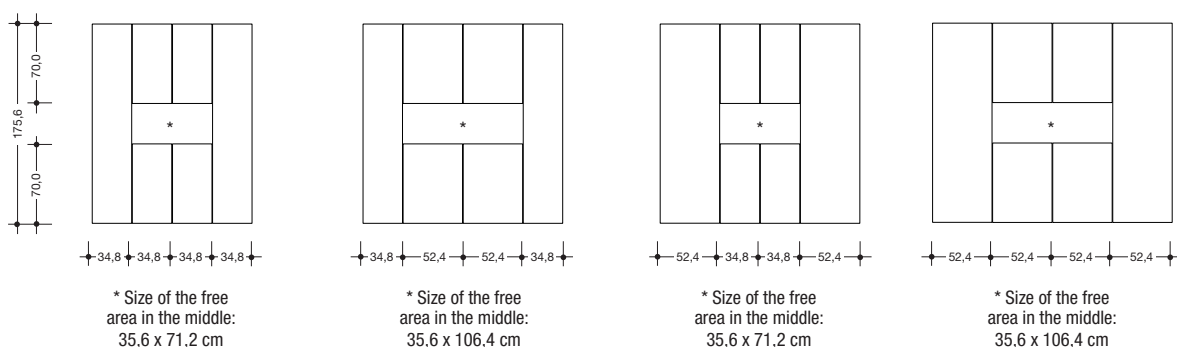

TV wall panel in Design Plain (A)

		140.8 cm wide	176.0 cm wide	176.0 cm wide	211.2 cm wide
175.6 cm high	Price gr.	43010080	43010101	43010102	43010120
		-	-	-	-
LED lamp for cover panel	LED lamps incl. foot switch. A radio remote control is possible for operation (against a surcharge).				
		for 140.8 cm width	for 176.0 cm width	for 176.0 cm width	for 211.2 cm width
		34,8 W	37,5 W	37,5 W	40,2 W
		0070154	0070155	0070155	0070156
		-	-	-	-

This product contains a light source of energy efficiency class D. 12 V.



Surcharges for TV wall panels in Design Plain (A) in price group II

		35.2 cm wide	52.8 cm wide
for TV wall panels, 52.4 cm high		76103020 -	76103030 -
for TV wall panels, 70.0 cm high		76104020 -	76104030 -
for TV wall panels, 140.4 cm high		76108020 -	76108030 -
for TV wall panels, 175.6 cm high		76110020 -	76110030 -

Surcharges for TV wall panels in Design Rear-lacquered glass (B)

		35.2 cm wide	52.8 cm wide
for TV wall panels, 52.4 cm high	Price gr. I II	76203020 - -	76203030 - -
for TV wall panels, 70.0 cm high	Price gr. I II	76204020 - -	76204030 - -
for TV wall panels, 140.4 cm high	Price gr. I II	76208020 - -	76208030 - -
for TV wall panels, 175.6 cm high	Price gr. I II	76210020 - -	76210030 - -

Surcharges for TV wall panels in Design Slat (C)

		35.2 cm wide	52.8 cm wide
for TV wall panels, 52.4 cm high	Price gr. I II	76303020 - -	76303030 - -
for TV wall panels, 70.0 cm high	Price gr. I II	76304020 - -	76304030 - -
for TV wall panels, 140.4 cm high	Price gr. I II	76308020 - -	76308030 - -
for TV wall panels, 175.6 cm high	Price gr. I II	76310020 - -	76310030 - -

Wall panels

Wall panels in Design Plain (A)

2.3 cm thick

Wall panels for fitting anywhere on walls



Wall panel in Design Plain (A)

		17.2 cm high	34.8 cm high	52.4 cm high	70.0 cm high	105.2 cm high	140.4 cm high	175.6 cm high
34.8 cm wide		44001021	44002021	44003021	44004021	44006021	44008021	44010021
	Price gr. I II	- -	- -	- -	- -	- -	- -	- -
52.4 cm wide		44001031	44002031	44003031	44004031	44006031	44008031	44010031
	Price gr. I II	- -	- -	- -	- -	- -	- -	- -
70.0 cm wide		44001041	44002041	44003041	44004041	44006041		
	Price gr. I II	- -	- -	- -	- -	- -		
105.2 cm wide		44001061	44002061	44003061				
	Price gr. I II	- -	- -	- -				

Wall panels in Design Rear-lacquered glass (B)

2.3 cm thick

Wall panels for fitting anywhere on walls



Wall panel in Design Rear-lacquered glass (B)

		17.2 cm high	34.8 cm high	52.4 cm high	70.0 cm high	105.2 cm high	140.4 cm high	175.6 cm high
34.8 cm wide		44001022	44002022	44003022	44004022	44006022	44008022	44010022
	Price gr. I II	- -	- -	- -	- -	- -	- -	- -
52.4 cm wide		44001032	44002032	44003032	44004032	44006032	44008032	44010032
	Price gr. I II	- -	- -	- -	- -	- -	- -	- -
70.0 cm wide		44001042	44002042	44003042	44004042	44006042		
	Price gr. I II	- -	- -	- -	- -	- -		
105.2 cm wide		44001062	44002062	44003062				
	Price gr. I II	- -	- -	- -				

Wall panels

Wall panels in Design Slat (C)

2.3 cm thick

Wall panels for fitting anywhere on walls

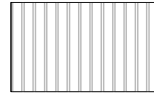

Wall panel in Design Slat (C)

		17.2 cm high	34.8 cm high	52.4 cm high	70.0 cm high	105.2 cm high	140.4 cm high	175.6 cm high
34.8 cm wide		44001024	44002024	44003024	44004024	44006024	44008024	44010024
	Price gr. I II	- -	- -	- -	- -	- -	- -	- -
52.4 cm wide		44001034	44002034	44003034	44004034	44006034	44008034	44010034
	Price gr. I II	- -	- -	- -	- -	- -	- -	- -
70.0 cm wide		44001044	44002044	44003044	44004044	44006044		
	Price gr. I II	- -	- -	- -	- -	- -		
105.2 cm wide		44001064	44002064	44003064				
	Price gr. I II	- -	- -	- -				

Angled shelves

The angled shelves may only be fitted on absolutely solid walls. Gypsum or other light masonry is not suitable for this purpose. Please be sure to note here the information and notes in the "Wall composition" chapter!





Angled shelves in Design Plain (A) 20.4 cm high; 23.4 cm deep Angled shelves for fitting anywhere on walls Max. load: 10 kg				
Angled shelf in Design Plain (A)			42114000	
70.4 cm wide	Price gr. I II		-	-
105.6 cm wide	Price gr. I II		-	-
Angled shelves in Design Rear-lacquered glass (B) 20.4 cm high; 23.4 cm deep Angled shelves for fitting anywhere on walls Max. load: 10 kg				
Angled shelf in Design Rear-lacquered glass (B)			42214000	
70.4 cm wide	Price gr. I II		-	-
105.6 cm wide	Price gr. I II		-	-
Angled shelves in Design Slat (C) 20.4 cm high; 23.4 cm deep Angled shelves for fitting anywhere on walls Max. load: 10 kg				
Angled shelf in Design Slat (C)			42314000	
70.4 cm wide	Price gr. I II		-	-
105.6 cm wide	Price gr. I II		-	-

Wall shelves

Wall shelves 2.9 cm thick; 23.4 cm deep for fitting anywhere on walls			
		70.4 cm wide	105.6 cm wide
		7024	1024
Price gr. I II		- -	- -

Lamps

LED lamps incl. foot switch. A radio remote control is possible for operation (against a surcharge).

<p>LED ambient light strip for fitting under wall units</p> <p>Later fitting is not possible.</p>  <p>This product contains a light source of energy efficiency class D. 12 V.</p> 	for 35.2 cm width	for 52.8 cm width	for 70.4 cm width	for 105.6 cm width
	1,6 W	2,7 W	3,9 W	7,0 W
	0070102	0070103	0070104	0070106
	-	-	-	-
	for 123.2 cm width	for 140.8 cm width	for 158.4 cm width	for 176.0 cm width
	7,0 W	9,8 W	9,8 W	12,5 W
0070107	0070108	0070109	0070110	
-	-	-	-	
for 193.6 cm width	for 211.2 cm width			
12,5 W	15,2 W			
0070111	0070112			
-	-			
<p>Integrated LED spotlamp Ø 7.1 cm; for fitting in open compartments and in units behind aluminium frame fronts</p> <p>Later fitting is not possible.</p>  <p>This product contains a light source of energy efficiency class F. 12 V.</p> 	2,9 W			
	7941			
	-			

Radio remote control with change of colour temperature

The lamps are normally operated by an external foot switch. The colour temperature of the LED lamps is cold white if a foot switch is used. A 4-channel radio remote control is also available as an alternative, which is charged extra. Several lamps can be operated with each of the 4 channels. All 4 channels can be dimmed separately at the push of a button. The colour temperature of all 4 channels can be set to any level from cold white (approx. 6500 kelvin = the basic setting of the LED lamps) to warm white (approx. 2700 kelvin). If warm white is required, a radio remote control must be ordered. It is also possible to switch all channels on and off simultaneously with the "all on" or "all off" buttons. The radio remote control consists of one transmitter and one receiver. If several receivers are required because of the arrangement of the units, these and the corresponding cables are provided ex-works (no surcharge). The foot switch is omitted when the radio remote control is used.



2119

-

Surcharges for carcasses

Surcharges for carcasses in price group II

	35.2 cm wide		52.8 cm wide		70.4 cm wide		88.0 cm wide	
	for 33.0 cm depth	for 45.0 cm depth	for 33.0 cm depth	for 45.0 cm depth	for 33.0 cm depth	for 45.0 cm depth	for 33.0 cm depth	for 45.0 cm depth
for carcasses, 2 Raster high	71102021 -	71102022 -	71102031 -	71102032 -	71102041 -	71102042 -	71102051 -	71102052 -
for carcasses, 3 Raster high	71103021 -	71103022 -	71103031 -	71103032 -	71103041 -	71103042 -	71103051 -	71103052 -
for carcasses, 4 Raster high	71104021 -	71104022 -	71104031 -	71104032 -	71104041 -	71104042 -	71104051 -	71104052 -
for carcasses, 6 Raster high	71106021 -	71106022 -	71106031 -	71106032 -	71106041 -	71106042 -	71106051 -	71106052 -
for carcasses, 7 Raster high	71107021 -	71107022 -	71107031 -	71107032 -	71107041 -	71107042 -	71107051 -	71107052 -
for carcasses, 8 Raster high	71108021 -	71108022 -	71108031 -	71108032 -	71108041 -	71108042 -	71108051 -	71108052 -
for carcasses, 10 Raster high		71110022 -		71110032 -		71110042 -		
for carcasses, 12 Raster high		71112022 -		71112032 -		71112042 -		
	105.6 cm wide		123.2 cm wide		140.8 cm wide			
	for 33.0 cm depth	for 45.0 cm depth	for 33.0 cm depth	for 45.0 cm depth	for 33.0 cm depth	for 45.0 cm depth		
for carcasses, 2 Raster high	71102061 -	71102062 -	71102071 -	71102072 -	71102081 -	71102082 -		
for carcasses, 3 Raster high	71103061 -	71103062 -	71103071 -	71103072 -	71103081 -	71103082 -		
for carcasses, 4 Raster high	71104061 -	71104062 -	71104071 -	71104072 -	71104081 -	71104082 -		
for carcasses, 6 Raster high	71106061 -	71106062 -	71106071 -	71106072 -	71106081 -	71106082 -		
for carcasses, 7 Raster high	71107061 -	71107062 -						
for carcasses, 8 Raster high	71108061 -	71108062 -						

Surcharges for carcasses in price group II

	158.4 cm wide		176.0 cm wide		193.6 cm wide		211.2 cm wide		
	for 33.0 cm depth	for 45.0 cm depth	for 33.0 cm depth	for 45.0 cm depth	for 33.0 cm depth	for 45.0 cm depth	for 33.0 cm depth	for 45.0 cm depth	
for carcasses, 2 Raster high	71102091	71102092	71102101	71102102	71102111	71102112	71102121	71102122	
	-	-	-	-	-	-	-	-	
for carcasses, 3 Raster high	71103091	71103092	71103101	71103102	71103111	71103112	71103121	71103122	
	-	-	-	-	-	-	-	-	
for carcasses, 4 Raster high	71104091	71104092	71104101	71104102	71104111	71104112	71104121	71104122	
	-	-	-	-	-	-	-	-	
for carcasses, 6 Raster high	71106091	71106092	71106101	71106102	71106111	71106112	71106121	71106122	
	-	-	-	-	-	-	-	-	

Surcharges for carcasses

Surcharges for centre partitions in price group II

		for 33.0 cm depth	for 45.0 cm depth
for centre partitions, 2 Raster high		71202001 -	71202002 -
for centre partitions, 3 Raster high		71203001 -	71203002 -
for centre partitions, 4 Raster high		71204001 -	71204002 -
for centre partitions, 6 Raster high		71206001 -	71206002 -
for centre partitions, 7 Raster high		71207001 -	71207002 -
for centre partitions, 8 Raster high		71208001 -	71208002 -
for centre partitions, 10 Raster high		X	71210002 -
for centre partitions, 12 Raster high		X	71212002 -

Surcharges for constructional shelves and fitted shelves in price group II

	for 35.2 cm width		for 52.8 cm width		for 70.4 cm width		for 105.6 cm width	
	for 33.0 cm depth	for 45.0 cm depth	for 33.0 cm depth	for 45.0 cm depth	for 33.0 cm depth	for 45.0 cm depth	for 33.0 cm depth	for 45.0 cm depth
	71300021 -	71300022 -	71300031 -	71300032 -	71300041 -	71300042 -	71300061 -	71300062 -

Surcharges for slide-in rear walls in Design Plain (A) in price group II

		35.2 cm wide	52.8 cm wide	70.4 cm wide
for slide-in rear walls, 2 Raster high		71402021 -	 	
for slide-in rear walls, 3 Raster high		71403021 -	71403031 -	
for slide-in rear walls, 4 Raster high		71404021 -	71404031 -	71404041 -
for slide-in rear walls, 6 Raster high		71406021 -	71406031 -	71406041 -

Surcharges for slide-in rear walls in Design Rear-lacquered glass (B)

		35.2 cm wide	52.8 cm wide	70.4 cm wide
for slide-in rear walls, 2 Raster high		71402022 - -	 	
for slide-in rear walls, 3 Raster high	Price gr. I II	71403022 - -	71403032 - -	
for slide-in rear walls, 4 Raster high	Price gr. I II	71404022 - -	71404032 - -	71404042 - -
for slide-in rear walls, 6 Raster high	Price gr. I II	71406022 - -	71406032 - -	71406042 - -

Surcharges for slide-in rear walls in Design Slat (C)

		35.2 cm wide	52.8 cm wide	70.4 cm wide
for slide-in rear walls, 2 Raster high		71402024 - -	 	
for slide-in rear walls, 3 Raster high	Price gr. I II	71403024 - -	71403034 - -	
for slide-in rear walls, 4 Raster high	Price gr. I II	71404024 - -	71404034 - -	71404044 - -
for slide-in rear walls, 6 Raster high	Price gr. I II	71406024 - -	71406034 - -	71406044 - -

Surcharges for fronts in Design Plain (A) in price group II

Surcharges for doors in Design Plain (A) in price group II

		35.2 cm wide	52.8 cm wide	70.4 cm wide
for doors, 2 Raster high		72102021 -		
for doors, 3 Raster high		72103021 -	72103031 -	
for doors, 4 Raster high		72104021 -	72104031 -	72104041 -
for doors, 5 Raster high		72105021 -	72105031 -	72105041 -
for doors, 6 Raster high		72106021 -	72106031 -	72106041 -
for doors, 7 Raster high		72107021 -	72107031 -	72107041 -
for doors, 8 Raster high		72108021 -	72108031 -	72108041 -
for doors, 9 Raster high		72109021 -	72109031 -	72109041 -
for doors, 10 Raster high		72110021 -	72110031 -	72110041 -
for doors, 12 Raster high		72112021 -	72112031 -	72112041 -

Surcharges for drawers in Design Plain (A) in price group II

		35.2 cm wide	52.8 cm wide	70.4 cm wide	105.6 cm wide
		for all depths	for all depths	for all depths	for all depths
for drawers, 1 Raster high		72201021 -	72201031 -	72201041 -	72201061 -
for drawers, 2 Raster high		72202021 -	72202031 -	72202041 -	72202061 -

Surcharges for flaps in Design Plain (A) in price group II

		35.2 cm wide	52.8 cm wide	70.4 cm wide	105.6 cm wide
for flaps, 2 Raster high		72302021 -	72302031 -	72302041 -	72302061 -
for flaps, 3 Raster high		72303021 -	72303031 -	72303041 -	72303061 -

Surcharges for fronts in Design Rear-lacquered glass (B)

Surcharges for doors in Design Rear-lacquered glass (B)

		35.2 cm wide	52.8 cm wide	70.4 cm wide
for doors, 2 Raster high	Price gr. I II	72102022 - -		
for doors, 3 Raster high	Price gr. I II	72103022 - -	72103032 - -	
for doors, 4 Raster high	Price gr. I II	72104022 - -	72104032 - -	72104042 - -
for doors, 6 Raster high	Price gr. I II	72106022 - -	72106032 - -	72106042 - -
for doors, 8 Raster high	Price gr. I II	72108022 - -	72108032 - -	
for doors, 10 Raster high	Price gr. I II	72110022 - -	72110032 - -	

Surcharges for drawers in Design Rear-lacquered glass (B)

		35.2 cm wide	52.8 cm wide	70.4 cm wide	105.6 cm wide
		for all depths	for all depths	for all depths	for all depths
for drawers, 1 Raster high	Price gr. I II	72201022 - -	72201032 - -	72201042 - -	72201062 - -
for drawers, 2 Raster high	Price gr. I II	72202022 - -	72202032 - -	72202042 - -	72202062 - -

Surcharges for flaps in Design Rear-lacquered glass (B)

		35.2 cm wide	52.8 cm wide	70.4 cm wide	105.6 cm wide
for flaps, 2 Raster high	Price gr. I II	72302022 - -	72302032 - -	72302042 - -	72302062 - -
for flaps, 3 Raster high	Price gr. I II	72303022 - -	72303032 - -	72303042 - -	72303062 - -

Surcharges for doors in Design Slat (C)

		35.2 cm wide	52.8 cm wide	70.4 cm wide
for doors, 2 Raster high	Price gr. I II	72102024 - -		
for doors, 3 Raster high	Price gr. I II	72103024 - -	72103034 - -	
for doors, 4 Raster high	Price gr. I II	72104024 - -	72104034 - -	72104044 - -
for doors, 6 Raster high	Price gr. I II	72106024 - -	72106034 - -	72106044 - -
for doors, 8 Raster high	Price gr. I II	72108024 - -	72108034 - -	
for doors, 10 Raster high	Price gr. I II	72110024 - -	72110034 - -	

Surcharges for drawers in Design Slat (C)

		35.2 cm wide	52.8 cm wide	70.4 cm wide	105.6 cm wide
		for all depths	for all depths	for all depths	for all depths
for drawers, 1 Raster high	Price gr. I II	72201024 - -	72201034 - -	72201044 - -	72201064 - -
for drawers, 2 Raster high	Price gr. I II	72202024 - -	72202034 - -	72202044 - -	72202064 - -

Surcharges for flaps in Design Slat (C)

		35.2 cm wide	52.8 cm wide	70.4 cm wide	105.6 cm wide
for flaps, 2 Raster high	Price gr. I II	72302024 - -	72302034 - -	72302044 - -	72302064 - -
for flaps, 3 Raster high	Price gr. I II	72303024 - -	72303034 - -	72303044 - -	72303064 - -

Surcharges for fronts in Design Glass (D)

Surcharges for Design Glass (D) – panel

		35.2 cm wide	52.8 cm wide	70.4 cm wide
for doors, 2 Raster high		72102025 -		
for doors, 3 Raster high		72103025 -	72103035 -	
for doors, 4 Raster high		72104025 -	72104035 -	72104045 -
for doors, 6 Raster high		72106025 -	72106035 -	72106045 -

Surcharges for Design Glass (D) – veneer-covered aluminium frame

		35.2 cm wide	52.8 cm wide	70.4 cm wide
for doors, 2 Raster high		72102023 -		
for doors, 3 Raster high		72103023 -	72103033 -	
for doors, 4 Raster high		72104023 -	72104033 -	72104043 -
for doors, 6 Raster high		72106023 -	72106033 -	72106043 -

Surcharges for drawers (instead of flaps)

		35.2 cm wide		52.8 cm wide		70.4 cm wide		105.6 cm wide	
		for 33.0 cm depth	for 45.0 cm depth	for 33.0 cm depth	for 45.0 cm depth	for 33.0 cm depth	for 45.0 cm depth	for 33.0 cm depth	for 45.0 cm depth
for drawers, 2 Raster high		0082220 -	0082221 -	0082230 -	0082231 -	0082240 -	0082241 -	0082260 -	0082261 -

Surcharges for open intermediate units in Design Plain (A) in price group II

		35.2 cm wide		52.8 cm wide	
		33.0 cm deep	45.0 cm deep	33.0 cm deep	45.0 cm deep
35.2 cm high		74102021 -	74102022 -	74102031 -	74102032 -
52.8 cm high		74103021 -	74103022 -	74103031 -	74103032 -

Surcharges for open intermediate units in Design Rear-lacquered glass (B)

		35.2 cm wide		52.8 cm wide	
		33.0 cm deep	45.0 cm deep	33.0 cm deep	45.0 cm deep
35.2 cm high	Price gr. I II	74202021 - -	74202022 - -	74202031 - -	74202032 - -
52.8 cm high	Price gr. I II	74203021 - -	74203022 - -	74203031 - -	74203032 - -

Surcharges for open intermediate units in Design Slat (C)

		35.2 cm wide		52.8 cm wide	
		33.0 cm deep	45.0 cm deep	33.0 cm deep	45.0 cm deep
35.2 cm high	Price gr. I II	74302021 - -	74302022 - -	74302031 - -	74302032 - -
52.8 cm high	Price gr. I II	74303021 - -	74303022 - -	74303031 - -	74303032 - -

Surcharges for wall panels

Surcharges for wall panels in Design Plain (A) in price group II

		34.8 cm wide	52.4 cm wide	70.0 cm wide	105.2 cm wide
for wall panels, 17.2 cm high		76101020 -	76101030 -	76101040 -	76101060 -
for wall panels, 34.8 cm high		76102020 -	76102030 -	76102040 -	76102060 -
for wall panels, 52.4 cm high		76103020 -	76103030 -	76103040 -	76103060 -
for wall panels, 70.0 cm high		76104020 -	76104030 -	76104040 -	
for wall panels, 105.2 cm high		76106020 -	76106030 -	76106040 -	
for wall panels, 140.4 cm high		76108020 -	76108030 -		
for wall panels, 175.6 cm high		76110020 -	76110030 -		

Surcharges for wall panels in Design Rear-lacquered glass (B)

		34.8 cm wide	52.4 cm wide	70.0 cm wide	105.2 cm wide
for wall panels, 17.2 cm high	Price gr. I II	76201020 - -	76201030 - -	76201040 - -	76201060 - -
for wall panels, 34.8 cm high	Price gr. I II	76202020 - -	76202030 - -	76202040 - -	76202060 - -
for wall panels, 52.4 cm high	Price gr. I II	76203020 - -	76203030 - -	76203040 - -	76203060 - -
for wall panels, 70.0 cm high	Price gr. I II	76204020 - -	76204030 - -	76204040 - -	
for wall panels, 105.2 cm high	Price gr. I II	76206020 - -	76206030 - -	76206040 - -	
for wall panels, 140.4 cm high	Price gr. I II	76208020 - -	76208030 - -		
for wall panels, 175.6 cm high	Price gr. I II	76210020 - -	76210030 - -		

Surcharges for wall panels in Design Slat (C)

		34.8 cm wide	52.4 cm wide	70.0 cm wide	105.2 cm wide
for wall panels, 17.2 cm high	Price gr. I II	76301020 - -	76301030 - -	76301040 - -	76301060 - -
for wall panels, 34.8 cm high	Price gr. I II	76302020 - -	76302030 - -	76302040 - -	76302060 - -
for wall panels, 52.4 cm high	Price gr. I II	76303020 - -	76303030 - -	76303040 - -	76303060 - -
for wall panels, 70.0 cm high	Price gr. I II	76304020 - -	76304030 - -	76304040 - -	
for wall panels, 105.2 cm high	Price gr. I II	76306020 - -	76306030 - -	76306040 - -	
for wall panels, 140.4 cm high	Price gr. I II	76308020 - -	76308030 - -		
for wall panels, 175.6 cm high	Price gr. I II	76310020 - -	76310030 - -		

Surcharges for cover panels for corner units

Surcharges for cover panels for corner units in price group II

	for 2 Raster height (35.2 cm high)	for 3 Raster height (52.8 cm high)	for 4 Raster height (70.4 cm high)	for 6 Raster height (105.6 cm high)	for 7 Raster height (123.2 cm high)	for 8 Raster height (140.8 cm high)	for 10 Raster height (176.0 cm high)	for 12 Raster height (211.2 cm high)
for all depths	72402000 -	72403000 -	72404000 -	72406000 -	72407000 -	72408000 -	72410000 -	72412000 -

Surcharges for side-panel system

Surcharges for side-panels in price group II

		for 6 Raster height	for 7 Raster height	for 8 Raster height	for 9 Raster height	for 10 Raster height	for 12 Raster height
for side-panels, top side-panels and wall side-panels		73106000 -	73107000 -	73108000 -	73109000 -	73110000 -	73112000 -

Surcharges for shelves in price group II

		for 35.2 cm width	for 52.8 cm width
for wooden shelves and depth-profiled shelf		73200020 -	73200030 -

Surcharges for work surface in price group II

for work surface		73400101 -
for lower side-panel for work surface		73404002 -

Surcharges for niche rear walls in Design Plain (A) in price group II

		35.2 cm wide	52.8 cm wide
for niche rear walls, 3 Raster high		73303021 -	73303031 -
for niche rear walls, 4 Raster high		73304021 -	73304031 -
for niche rear walls, 6 Raster high		73306021 -	73306031 -

Surcharges for niche rear walls in Design Rear-lacquered glass (B)

		35.2 cm wide	52.8 cm wide
for niche rear walls, 3 Raster high	Price gr. I II	73303022 - -	73303032 - -
for niche rear walls, 4 Raster high	Price gr. I II	73304022 - -	73304032 - -
for niche rear walls, 6 Raster high	Price gr. I II	73306022 - -	73306032 - -

Surcharges for niche rear walls in Design Slat (C)

		35.2 cm wide	52.8 cm wide
for niche rear walls, 3 Raster high	Price gr. I II	73303024 - -	73303034 - -
for niche rear walls, 4 Raster high	Price gr. I II	73304024 - -	73304034 - -
for niche rear walls, 6 Raster high	Price gr. I II	73306024 - -	73306034 - -

Surcharges for angled shelves

Surcharges for angled shelves in Design Plain (A) in price group II

		70.4 cm wide	105.6 cm wide
for angled shelves		77201041 -	77201061 -

Surcharges for angled shelves in Design Rear-lacquered glass (B)

		70.4 cm wide	105.6 cm wide
for angled shelves	Price gr. I II	77201042 - -	77201062 - -

Surcharges for angled shelves in Design Slat (C)

		70.4 cm wide	105.6 cm wide
for angled shelves	Price gr. I II	77201043 - -	77201063 - -

Surcharges for wall shelves

Surcharges for wall shelves in price group II

		70.4 cm wide	105.6 cm wide
for wall shelves		77101040 -	77101060 -



Switch options for lamps: Radio remote control with change of colour temperature

Radio remote control with change of colour temperature

The lamps are normally operated by an external foot switch. The colour temperature of the LED lamps is cold white if a foot switch is used. A 4-channel radio remote control is also available as an alternative, which is charged extra. Several lamps can be operated with each of the 4 channels. All 4 channels can be dimmed separately at the push of a button. The colour temperature of all 4 channels can be set to any level from cold white (approx. 6500 kelvin = the basic setting of the LED lamps) to warm white (approx. 2700 kelvin). If warm white is required, a radio remote control must be ordered. It is also possible to switch all channels on and off simultaneously with the "all on" or "all off" buttons. The radio remote control consists of one transmitter and one receiver. If several receivers are required because of the arrangement of the units, these and the corresponding cables are provided ex-works (no surcharge). The foot switch is omitted when the radio remote control is used.

The following points must be noted with the radio remote control:

- The receiver must be positioned behind a rear wall or under plinth shelves (at least 20 mm space required under plinth shelves).
- The total wattage power of all lamps included per receiver must not exceed 30 W.
- 4 channels = 4 light groups
- 1 light group = x lights
- All lamps within a light group can be dimmed to the same brightness.
- The change of the colour temperature takes place for all lamps in all light groups.
- The radio remote control is not suitable for equipment operating on 110 V.

Please be sure to note the operating and programming instructions!

4-channel radio remote control with change of color temperature



4-channel radio remote control with change of color temperature

Type	2119	-
------	------	---

Examples of use (schematic diagrams)

Example 1

Lights inside a unit

Channel 1 operates (and dims) all the lights in light group 1, i.e. the LED spotlamp in the left cabinet

Channel 2 operates (and dims) all the lights in light group 2, i.e. the LED spotlamps in the open compartment

Channel 3 operates (and dims) all the lights in light group 3, i.e. the LED spotlamp in the right cabinet

Notes:

The total wattage power of all lamps included per receiver must not exceed 30 W. The change of the colour temperature takes place for all lamps in all light groups.

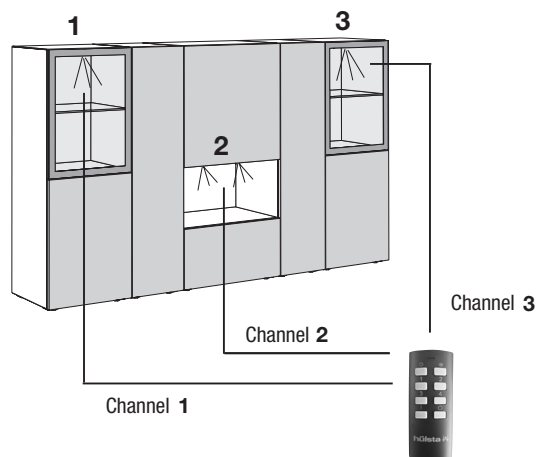

Example 2

Lights in units set apart

Channel 1 operates (and dims) all the lights in light group 1, i.e. the LED spotlamp and the LED light panels in the left cabinet

Channel 2 operates (and dims) all the lights in light group 2, i.e. the LED spotlamps and the LED light panels in the centre cabinet

Channel 3 operates (and dims) all the lights in light group 3, i.e. the LED spotlamp and the LED light panels in the right cabinet

Notes:

The total wattage power of all lamps included per receiver must not exceed 30 W. The change of the colour temperature takes place for all lamps in all light groups.

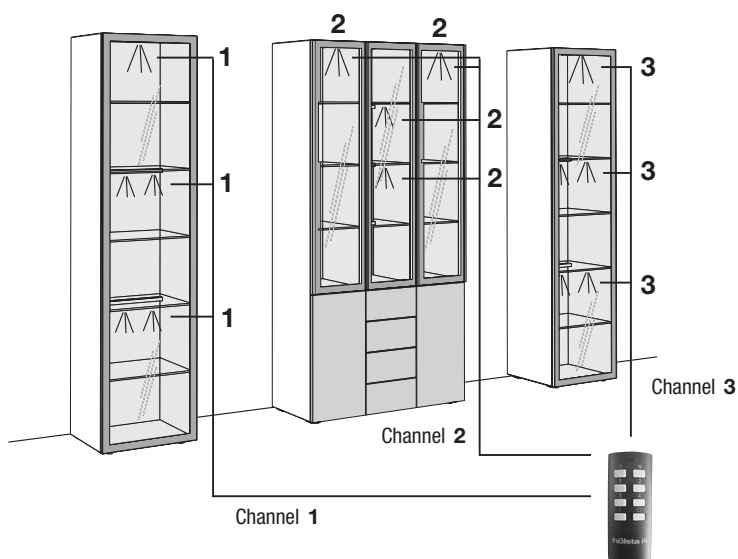

Example 3

Lights in units set apart

Channel 1 operates (and dims) all the lights in light group 1, i.e. the LED spotlamps in the left, centre and right cabinet

Channel 2 operates (and dims) all the lights in light group 2, i.e. the top LED light panels in the left, centre and right cabinet

Channel 3 operates (and dims) all the lights in light group 3, i.e. the bottom LED light panels in the left, centre and right cabinet

Notes:

The total wattage power of all lamps included per receiver must not exceed 30 W. The change of the colour temperature takes place for all lamps in all light groups.

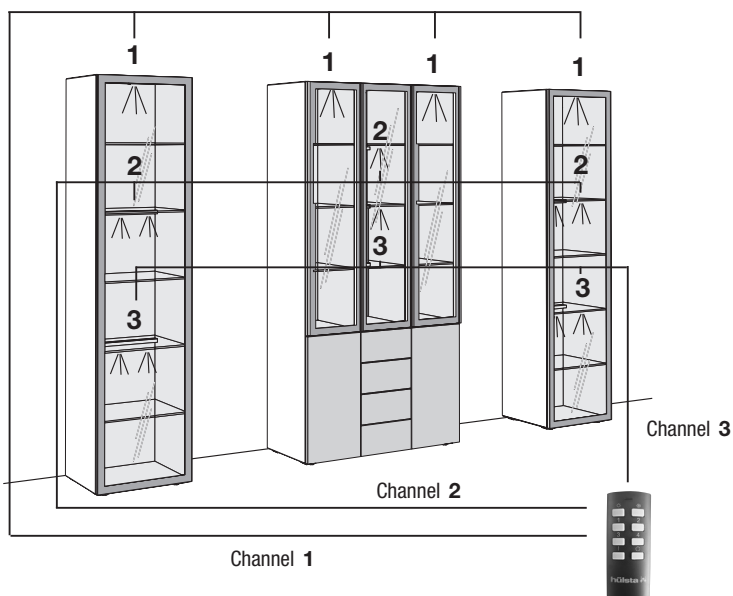

Important notes

Wall composition / assembly instruction

Important notes:

The composition of walls must be ascertained before concluding a contract and be checked by a qualified fitter before assembly takes place.







Assembly may only be carried out by a qualified fitter under careful observation of the assembly instructions.

The plastic Rawl plugs supplied by hülsta as a standard set are only suitable for concrete \geq C12/15, if the wall composition and compression strength corresponds to the table below. Under no circumstances must a unit be assembled on light masonry.

Furthermore, we provide a mounting set with assembly mortar for the types of walls listed below (see assembly mortar set below). Again, assembly must be carried out by a qualified fitter under careful observation of the wall composition and assembly instruction. The compression strength levels stated below must be met under all circumstances.

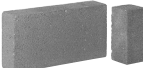
Materials table

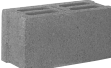
with a description of which sets are to be used with the following types of walls:

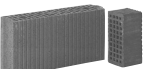
Standard set	Assembly mortar set only suitable for the materials stated below!
Concrete C12/15 Compression strength \geq 15 N/mm ² 	<div style="display: flex; flex-wrap: wrap;"> <div style="width: 50%;">  <p>Building bricks Mz 12 Compression strength \geq 12 N/mm²</p> </div> <div style="width: 50%;">  <p>Solid blocks of light concrete V2 Compression strength \geq 2 N/mm²</p> </div> <div style="width: 50%;">  <p>Limestone blocks KS 12 Compression strength \geq 12 N/mm²</p> </div> <div style="width: 50%;">  <p>Perforated blocks of light concrete Hbl 2 Compression strength \geq 2 N/mm²</p> </div> <div style="width: 50%;">  <p>Perforated sand lime bricks KSL12 Compression strength \geq 12 N/mm²</p> </div> <div style="width: 50%;">  <p>Aerated concrete PP2 Compression strength \geq 2 N/mm²</p> </div> <div style="width: 50%;">  <p>Vertically perforated bricks HLz 12 Compression strength \geq 12 N/mm² Bulk density \geq 1.0 kg/dm³</p> </div> </div>

A different and more suitable type of mounting must be chosen by a qualified fitter in all other cases. hülsta cannot accept any responsibility for the choice of any other types of mounting! Please note that if the units are not mounted properly on the wall, there is a risk of the units falling down or tipping over – especially when alternative mounting materials acquired on site have been used. Generally speaking, you as a dealer/qualified fitter are responsible for the correct wall mounting of the units.



Mounting sets

Labelling in type list drawings / assembly notes for wall units

The majority of units have two wall mounting points (= number of support boards), if these are to be fitted as wall units. This is not explicitly mentioned in the type list. If a different number of wall mounting points (= support boards) is required, this is marked in the drawings in the type list with numbers in black boxes. Every support board requires four mounting screws.

3 = 3 support boards

4 = 4 support boards, etc.

One **assembly mortar set** is sufficient for up to a maximum of 3 support boards or 4 wall side-panels.

Important note: Depending on the composition of the wall (see wall types illustrated above), assembly must be carried out using the special assembly mortar set and a standard trade mastic tool which are the basic essentials for safe and clean workmanship.

Standard set

The standard set consists of 4 plastic Rawl plugs and 4 mounting screws and is sufficient for 1 support board. The standard sets are included in the packet of fittings to match the number of support boards.

Assembly mortar set for up to a maximum of 3 support boards consisting of:

9x injection retaining sleeve
 9x screw-in sleeve
 1x injection cartridge
 2x static mixer
 1x assembly instructions

Please use the mounting screws from the standard set (supplied free of charge).

Example of order:

- Add up number of support boards for all existing unit types
 - Divide the sum by "3"
 - Round up the result to a full number
- = Number of assembly mortar sets required

M2

-

hülsta SPECTRUM Wohnen

Stand: E 1.2024

Design and concept legally protected, subject to error and alterations to construction, colour and materials by way of technological progress.

hülsta-werke · Karl-Hüls-Straße 1 · D-48703 Stadtlohn
Tel. +49 (0) 2563 / 86-0 · Fax +49 (0) 2563 / 86-1000
www.huelsta.com

